



HYDROQUIP™

STANDARD SERIES SOLID-STATE

SYSTEM OPERATION MANUAL

THE SMART CHOICE™

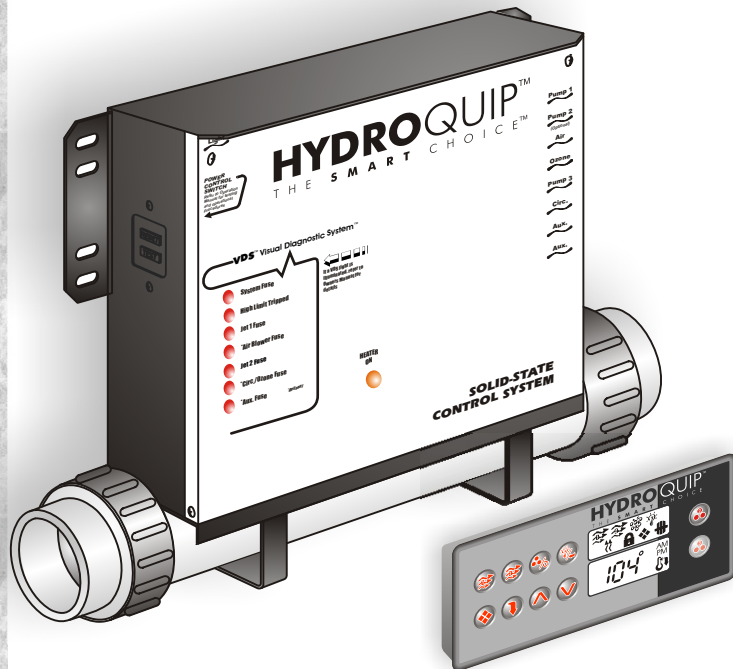

9300

CONTENTS

Important Safety Instructions 2

INTRODUCTION

Major Component Illustration 4

SYSTEM OPERATION

Illustration 5

GFCI (Ground Fault Circuit Interrupter) 6

Power Switch 7

Power Detection Switch (optional) 7

Heater “On” Indicator 7

Visual Diagnostic System (optional) 8

Lighted Cord Connection (optional) 10

Heater Operation 10

Spaside Control 11

Additional Features 13

Error Identification 14

Spa Light 14

OPERATIONAL CONSIDERATIONS

Warm Weather Conditions 15

Filtration 15

Freeze Protection & Winterizing 15

Chemical Water Treatment 16

TROUBLESHOOTING 16

Data Label Information 19

Warranty Information 20

Notes 21

On the World Wide Web . . .

IMPORTANT SAFETY INSTRUCTIONS

READ AND FOLLOW ALL INSTRUCTIONS

! **DANGER** To reduce the risk of injury, do not permit children to use this product unless they are closely supervised at all times.

! **WARNING - RISK OF CHILD DROWNING.** Extreme caution must be exercised to prevent unauthorized access by children. To avoid accidents, ensure that children cannot use a spa or hot tub unless they are supervised at all times.

! **DANGER** To reduce the risk of injury to persons, do not remove suction fittings.

▶ Spa location must accommodate sufficient drainage of water around the base of the structure, as well as the power source compartment.

▶ Prolonged immersion in water that is warmer than normal body temperature can result in a dangerous condition known as HYPERTHERMIA. The causes, symptoms, and effects of hyperthermia may be described as follows: Hyperthermia occurs when the internal temperature of the body reaches a level several degrees above the normal body temperature of 98.6°F. The symptoms of hyperthermia include dizziness, fainting, drowsiness, lethargy, and an increase in the internal temperature of the body. The effects of hyperthermia include (1) unawareness of impending hazard, (2) failure to perceive heat, (3) failure to recognize the need to exit spa, (4) physical inability to exit spa, (5) fetal damage in pregnant women, (6) unconsciousness resulting in danger of drowning. **WARNING** The use of alcohol, drugs or medication can greatly increase the risk of fatal hyperthermia in hot tubs and spas.

! **DANGER - RISK OF ELECTRICAL SHOCK.** Install at least 5 feet (1.5m) from all metal surfaces. (A spa may be installed within 5 feet of metal surfaces if each metal surface is permanently connected by a solid copper conductor attached to the wire connector on the terminal box that is provided for this purpose. Refer to NEC and local codes in effect at the time of installation.)

▶ A pressure wire connector is provided on the control box to permit connection of a solid copper bonding conductor between this point and any equipment, metal enclosures of electrical equipment, metal water pipe, or conduit within 5 feet (1.5m) of the unit as needed to comply with local requirements.

▶ Bond accessible metal to the dedicated connector on the equipment grounding bus, bond the equipment ground bus to the local common bonding grid as part of the installation in the form of (1) a reinforced concrete slab for support, (2) a ground plate provided beneath the hot tub or spa, or (3) a permanent ground connection that is acceptable to the local inspection authority.

! **DANGER RISK OF ELECTRICAL SHOCK.** Do not permit any electrical appliance, such as a light, telephone, radio, or television, within 5 feet (1.5m) of a spa or hot tub.

To reduce the risk of injury:

▶ The water in a spa or hot tub should never exceed 104°F (40°C). Water temperatures between 100°F (38°C) and 104°F (40°C) are considered safe for a healthy adult. Lower water temperatures are recommended for extended use (exceeding 10-15 minutes) and for young children.

▶ Excessive water temperatures have a high potential for causing fetal damage during the early months of pregnancy, pregnant or possibly pregnant women should limit spa or hot tub water temperatures to 100°F(38°C).



Before entering the spa or hot tub, the user should measure the water temperature with an accurate thermometer.

The use of alcohol, drugs, or medication before or during spa or hot tub use may lead to unconsciousness with the possibility of drowning.

Persons suffering from obesity or with a medical history of heart disease, low or high blood pressure, circulatory system problems, or diabetes should consult a physician before using a spa or hot tub.

Persons using medication should consult a physician before using a spa or hot tub since some medication may affect heart rate, blood pressure, and circulation.

For Units with a GFCI (Ground Fault Circuit Interrupter)

This appliance is provided with a ground-fault-circuit-interrupter located on the control box. Before each use and with the unit operating, push the test button. The unit should stop operating and the reset button should appear. Push the reset button. The unit should now operate normally. If the interrupter does not perform in this manner, a ground current is flowing indicating the possibility of electrical shock. Disconnect the power, or unplug from receptacle, until the fault has been identified and corrected.

For Cord and Plug Connected Units

Connected to a grounded, grounding type receptacle only. NEVER connect the spa to an extension cord.

Do not bury the cord.

WARNING To reduce the risk of electrical shock, replace damaged cord immediately.

For Permanently Installed Units

A terminal marked "G" or "ground" is provided in the wiring box located inside the equipment compartment. To reduce the risk of electric shock, connect the terminal or connector to the grounding terminal of your electrical service or supply panel with a continuous green insulated copper wire in accordance with National Electric Code Table 250-95 and any other local codes in effect at the time of the installation.

For Permanently Installed Units not Provided with an Internal Disconnecting Method

The electrical supply for this product must include a suitably rated switch or circuit breaker to open all ungrounded supply conductors to comply with Section 422-30 of the National Electric Code, ANSI/NFPA 70 1987. The disconnecting means must be readily accessible to the tub occupant but installed at least 5 feet (1.5m) from the tub water.

For Units with Gas Heaters

WARNING - Do not install indoors. This unit uses a gas heater that requires proper ventilation and is intended for outdoor use only.

For UL Listed Equipment Assemblies

Install at least 5 feet (1.5m) from tub water using nonmetallic plumbing. Install blower no less than 1 foot (305mm) above the maximum water level to prevent water from contacting electrical equipment. Install in accordance with the installation instructions. To reduce the risk of drowning from hair and body entrapment, install a suction fitting(s) with a marked flow rate in gallons-per-minute that equals or exceeds the flow rate marked on the equipment assembly.

INTRODUCTION

Congratulations on your new purchase. **Hydro-Quip** Equipment & Control Systems are constructed of the finest materials and assembled under the strictest quality control standards. With proper care and maintenance your system will provide you with many years of reliable performance.

The following pages contain Information concerning the operation and care of your system.

(Note: Your Control may differ from the illustration below although the basic operation and configuration will be the same.)

Major Components

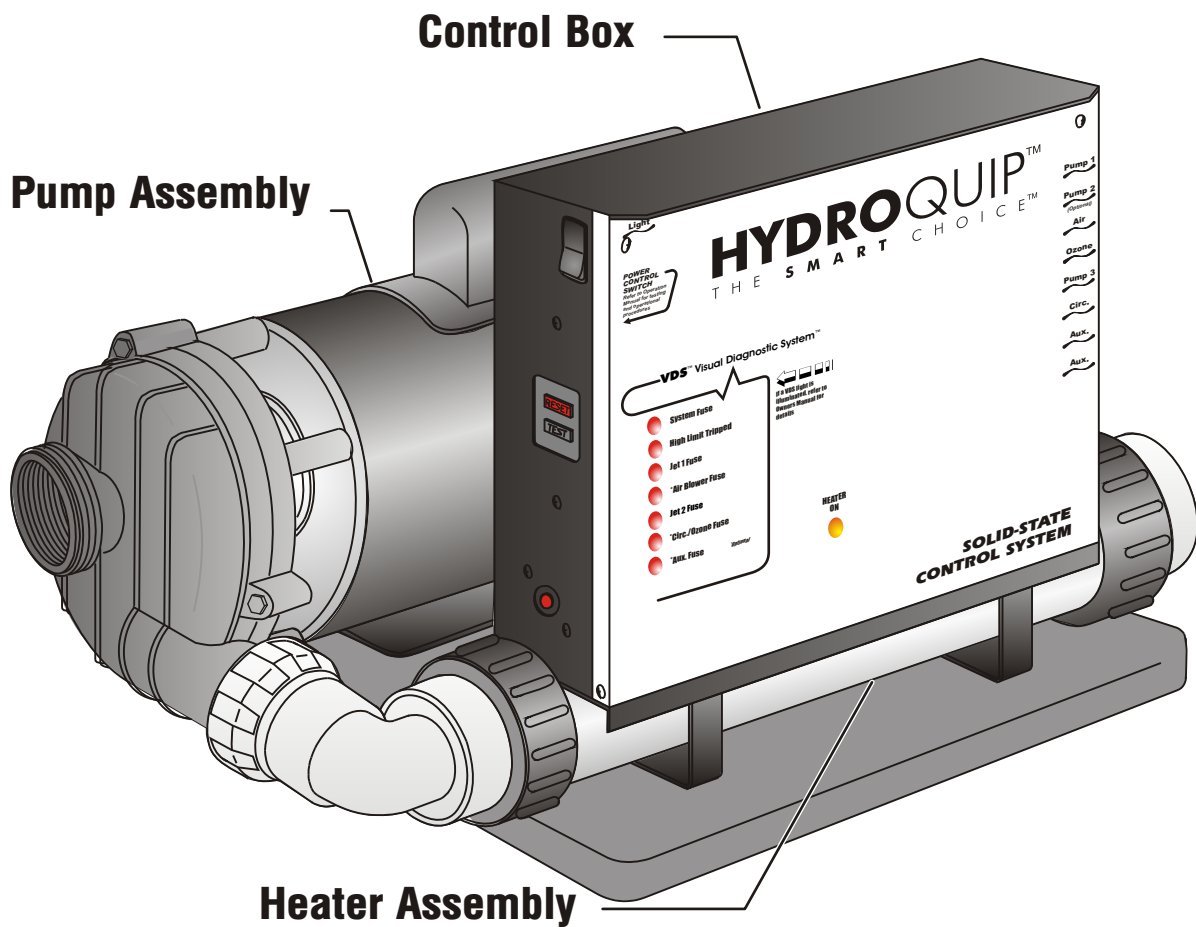

SYSTEM OPERATION

Note: Your particular control may look different than these illustrations though the operation is the same.

Refer to the following pages and the number that corresponds with the number shown in these illustrations for detailed instructions.

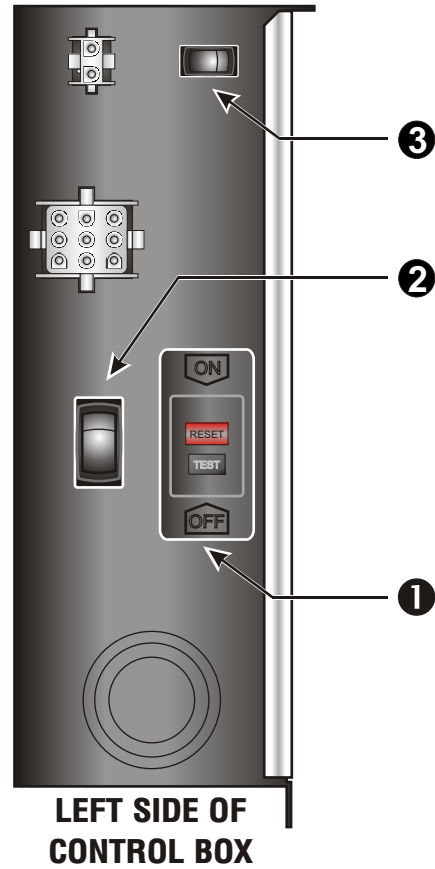

LEFT SIDE OF CONTROL BOX

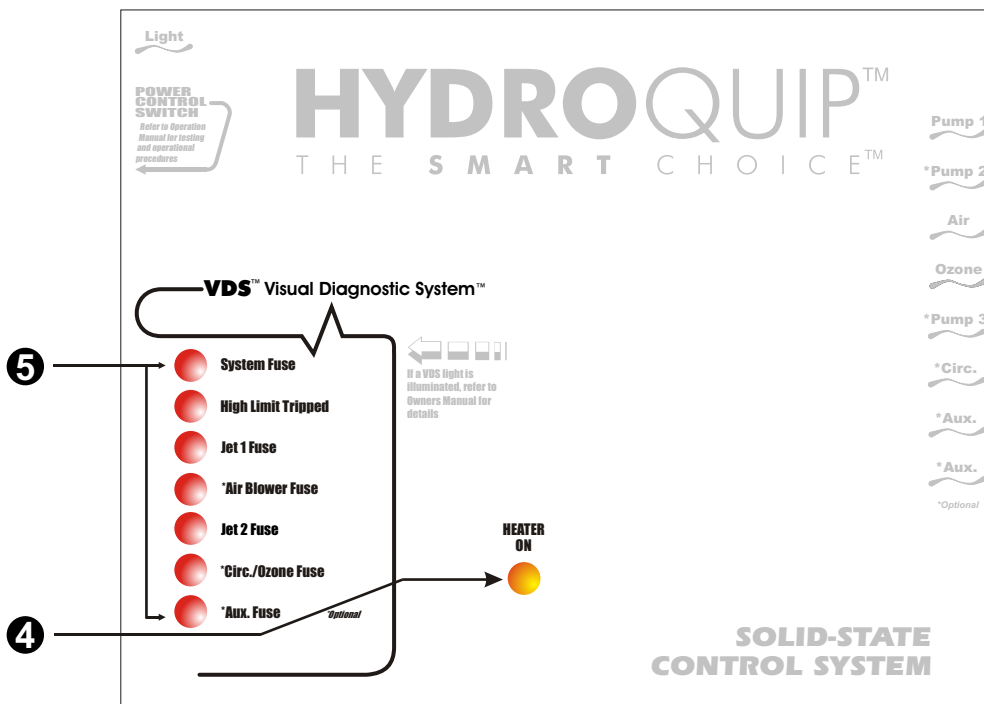

FRONT PANEL

1 GFCI (Ground Fault Circuit Interrupter) (OPTIONAL)

The GFCI is a mandatory electrical safety device required for all portable spas and hot tubs as specified in the National Electrical Code Article 680. The GFCI is designed to provide protection against potential electrical shock hazard should a ground fault occur.

The installation of a properly sized Ground Circuit and Bonding Circuit is still required as detailed in the Installation Manual. The GFCI in your particular installation may be installed at the electrical service panel, a separate sub-panel or built into your Hydro-Quip spa control system.

Systems with a built-in GFCI meeting the code requirements will be marked on the top of the control panel with identification label.

It is necessary to test the GFCI before each use and at least monthly when the spa or hot tub is not being used regularly.

Test the device in the following manner:

- With the power on, push the “TEST” button; there should be an audible “click”, which will disconnect the power to the system. The “RESET” button will pop out slightly.

CAUTION - if the GFCI fails to operate in this manner, do not use the spa until a qualified technician has corrected the problem.

- To restore power, press the red “RESET” button in.

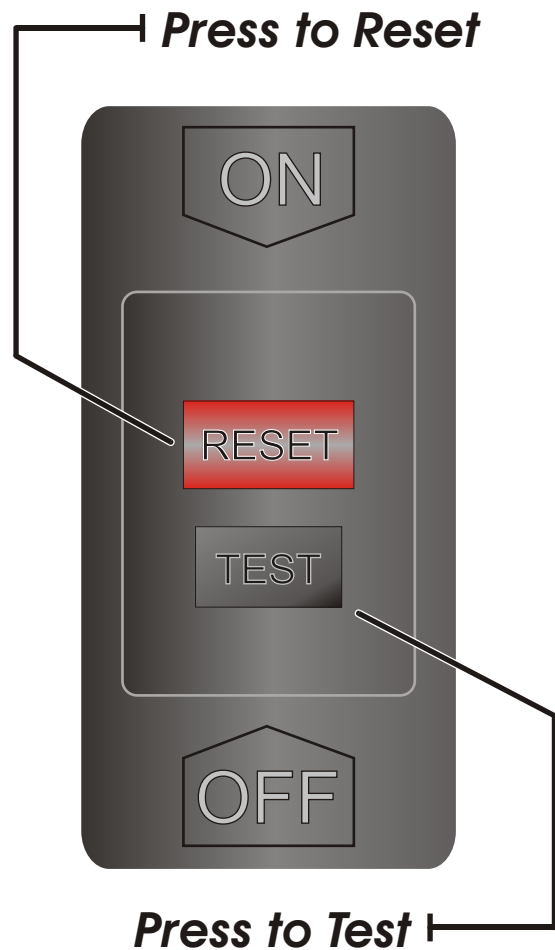

2 POWER SWITCH (optional)

If equipped, your system may incorporate a power switch. This switch will turn power either on or off to the internal circuitry and connected components

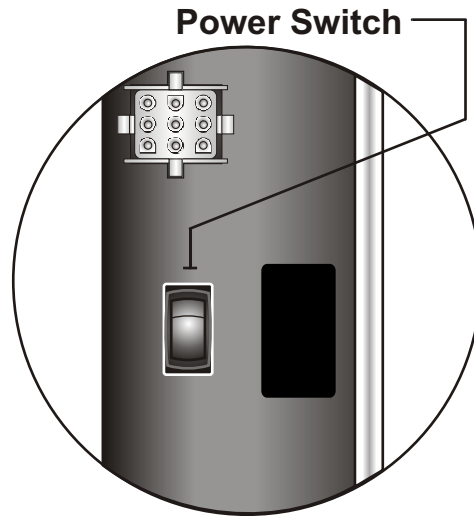

3 POWER DETECTION SWITCH (optional)

The power test switch allows you to verify that voltage is being supplied to your system.

Simply press the switch toward the rear of the enclosure to see the Line 1 voltage indicator illuminate then press the switch toward the front of the enclosure to see the Line 2 voltage indicator (240-Volt Models only) illuminate.

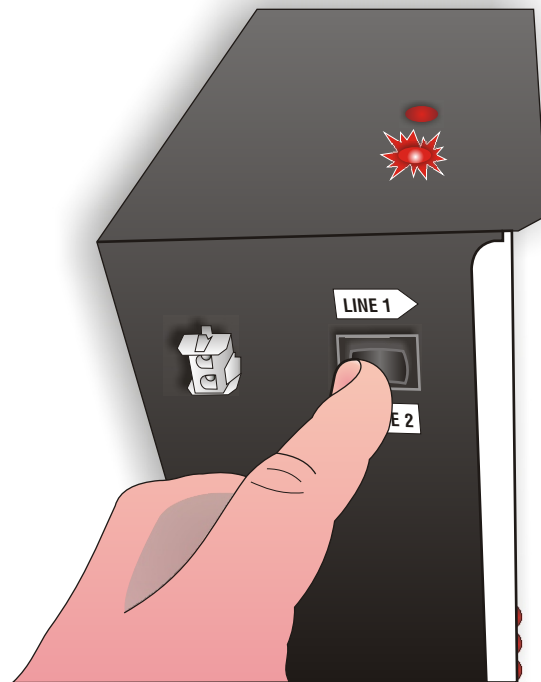

4 HEATER "ON" INDICATOR

This indicator light activates when the heater is "on". It is a diagnostic tool for service technicians.

**HEATER
ON**



5 VDS-Visual Diagnostic System (optional)

If your system is equipped with Hydro-Quip's exclusive, Visual Diagnostic System, your control will do the troubleshooting for you. VDS consist of control-mounted indicators and (if equipped) lighted component cords. You will know at a glance if a component is being supplied with the proper voltage, if a fuse has blown or (by simply pressing a switch) if the complete system is being supplied with voltage from the breaker panel. The following information will guide you through the Visual Diagnostic System:

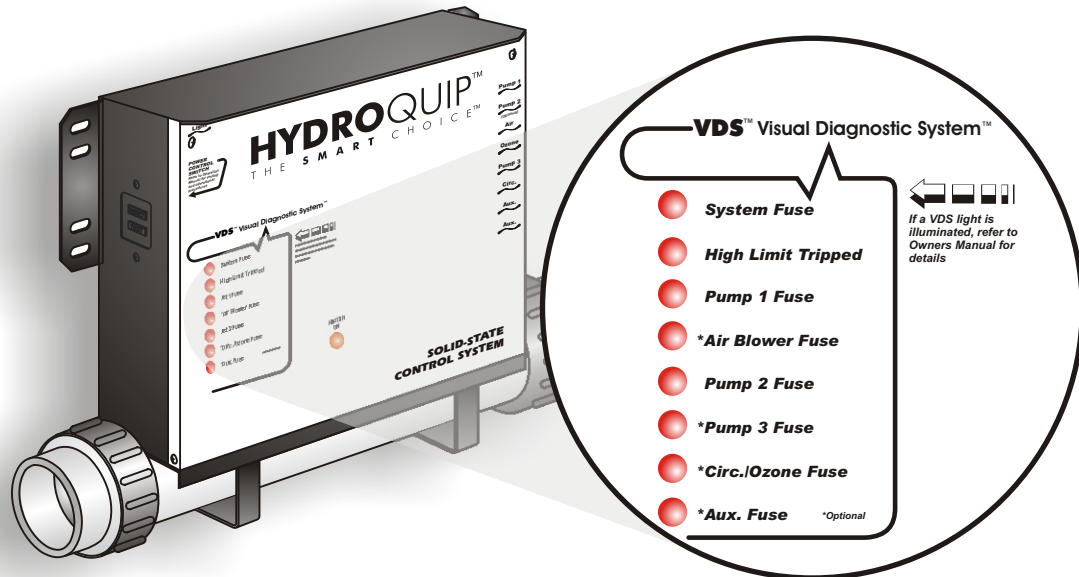

TROUBLESHOOTING VDS

VDS INDICATOR ILLUMINATED

POSSIBLE PROBLEM

<p>SYSTEM FUSE - This fuse protects the printed circuit board.</p>	<p>Input voltage connected incorrectly, defective transformer. Call your local dealer or qualified technician.</p>
<p>HIGH-LIMIT TRIPPED - Over temperature condition, do not enter spa .</p>	<p>Restricted flow of water caused by dirty filter, improperly adjusted jets, water shutoff valve not fully open or debris in plumbing. Call your local dealer or qualified technician.</p>
<p>PUMP 1 FUSE - Protects the primary pump.</p>	<p>Restricted flow of water, faulty pump or severe weather/electrical storm. Call your local dealer or qualified technician.</p>

TROUBLESHOOTING VDS (cont.)

VDS INDICATOR LIGHT

POSSIBLE PROBLEM

<p>AIR BLOWER FUSE - This fuse protects the air blower.</p>	<p>Faulty blower or severe weather / electrical storm. Call your local dealer or qualified technician.</p>
<p>PUMP 2 FUSE - Protects the secondary pump.</p>	<p>Restricted flow of water, faulty pump or severe weather/electrical storm. Call your local dealer or qualified technician.</p>
<p>PUMP 3 FUSE - Protects an auxiliary pump.</p>	<p>Restricted flow of water, faulty pump or severe weather/electrical storm. Call your local dealer or qualified technician.</p>
<p>CIRC./OZONE FUSE - Protects a circulation pump and/or ozonator.</p>	<p>Restricted flow of water, faulty pump and/or ozonator or severe weather/electrical storm. Call your local dealer or qualified technician.</p>
<p>AUXILIARY FUSE - Protects spa fiber optics.</p>	<p>Faulty fiber optic system or severe weather/electrical storm. Call your local dealer or qualified technician.</p>

Your particular system may not include all of the components listed. If a component continually blows the fuse, the component may be defective. Contact your local spa dealer or a qualified technician.

LIGHTED CORD CONNECTION (optional)

If equipped, the cords that connect the vital components of your spa to the control have been equipped with internal diagnostic indicators. Whenever a component is operating, that components corresponding plug connection will illuminate to let you know that proper voltage is being supplied.

As a diagnostic tool, if a component is not functioning, a simple glance will tell you if proper voltage is being supplied to that component. If the plug is illuminated but the component is not operating, the component may be defective.

If the plug is not illuminated, the components fuse indicator should be illuminated. If it is not, use the power test switch to ensure that voltage is being supplied to the system.

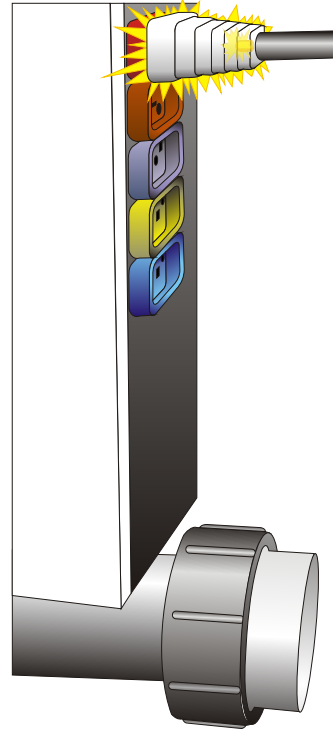

HEATER OPERATION

Your control system may have a convertible heater (120 volts; or 240 volts). Refer to the system data label to determine which, if any, convertible options are available to you. The heater configuration was set at the factory and may have been changed by your installer.

A covered, 300-gallon spa will experience a heat rise approximately as detailed below.

Your system will operate with one of the following configurations:

120 Volts - The heater will operate on demand at 1500 Watts during low speed pump operation. It will automatically shut off when the high-speed pump or blower is activated. You can expect a heat rise of 1°F to 2°F per hour.

240 Volt - The heater will operate on demand at 5500 Watts during high and low speed pump operation. It will continue to operate when the blower is activated. You can expect a heat rise of 6°F to 8°F per hour.

YOUR SPASIDE CONTROL

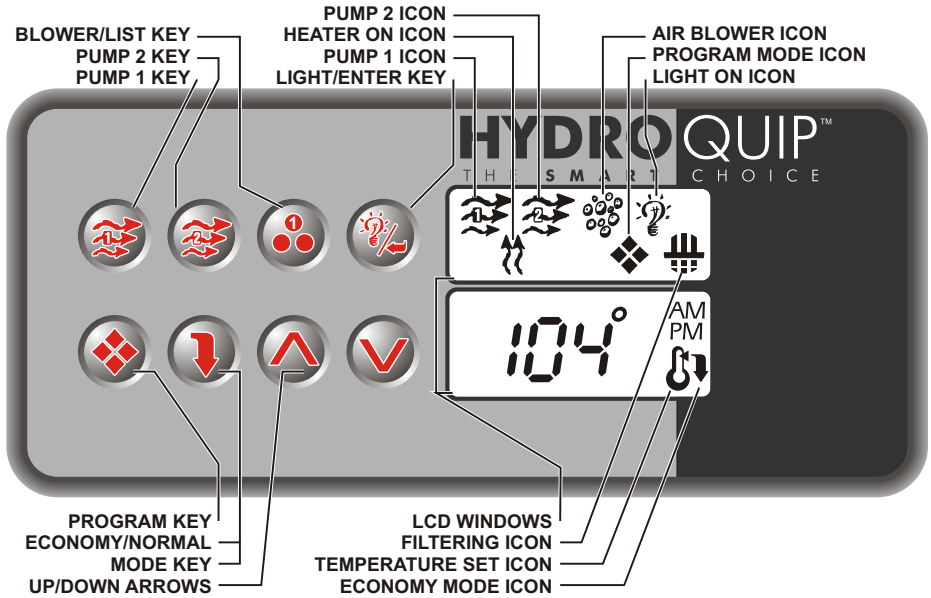

Default System Operation: When power is applied, or there is a temporary loss of power, the system will initiate its default programming. The filter cycle will begin 24-hours after the system has been powered up. The filtration cycle will be active for 1-hour and will repeat every 24-hours. The temperature will be maintained at 95°F.



Pump 1 Key: Press this key once to turn Pump 1 on. A second press will turn it off. For dual speed pump operation; Press this key once to turn Pump 1 onto Low speed, press this key a second time to turn Pump 1 onto High speed, a third press will turn the pump off. A built-in timer will shut the pump off after 20 minutes of operation unless done so manually. The Pump 1 Icon will appear on the LCD while the pump is running in High speed and flash while it is in Low speed. If the filter icon appears, a filtration cycle has begun and you will not be able to turn the pump off.



Pump 2 Key: Press this key once to turn Pump 2 on. A second press will turn it off. For dual speed pump operation; Press this key once to turn Pump 2 onto Low speed, press this key a second time to turn Pump 2 onto High speed, a third press will turn the pump off. A built-in timer will shut the pump off after 20 minutes of operation unless done so manually. The Pump 2 Icon will appear while the pump is running in High speed and flash while it is in Low speed.

SPASIDE CONTROL - Continued



Blower Key: Press this key once to turn Blower onto High speed, a second press will turn the Blower onto Medium speed, a third press will turn the Blower onto Low speed and a fourth press will turn the Blower off. A built-in timer will shut the blower off after 20 minutes of operation unless done so manually. The Blower Icon will appear while the blower is running in High speed and flash while it is in Medium and Low speeds.



Light/Enter Key: Press this key to turn the light onto its highest intensity, a second press will turn the light onto medium, a third press will turn the light onto low and a fourth press will turn it off. If equipped with Fiber Optic: Press this key once to show "L1". Use the Up arrow key to turn the light onto High, Medium, Low and Off. Press the light key a second time, "F1" will appear. Use the Up arrow key to turn the Fiber Optic wheel and light on, Fiber Optic wheel off with light on and both Off. The light will automatically shut off after 2 hours. The Light Icon will appear while the light is on.



Temperature Set Keys: Press the Up Arrow key to increase the desired temperature. Press the Down Arrow key to decrease the temperature. The temperature can be adjusted in 1°F increments from 59°F to 104°F (5°C to 40°C). The new setting will remain on the display for 5 seconds as a confirmation. During this time the Set Point icon will be appear to let you know this is the desired and not the actual temperature. After 5 seconds the display will return to the current temperature reading. When the temperature drops to 1°F below the set temperature, the heater will be turned on until the temperature is 1°F above the set temperature. The heater icon will appear while the heater is on and flash when there is a call for heat and the heater has not yet been activated.



Programming Parameters: This key is used to program the filter cycle. Follow these procedures to set each parameter: (1) Press the Program Key; the display shows the current duration of the filter cycle "F" followed by 0 to 12. (2) Once the parameter is displayed, use the Up/Down arrows to adjust the setting. The filter cycle is activated every 12-hours. The duration can be set from 0 (never on) to 12 (always on). (3) Press the Program key to begin a filter cycle. The filter icon will appear while the filter cycle is operating.



Economy Mode: Press this key to toggle between Economy and Normal operation. The Normal Mode will automatically maintain the water temperature at the desired set point. If the set point has not been programmed, the temperature will remain at 95°F. The **Economy Mode** will maintain the water temperature at 20°F below the set point until manually removed from this mode. When the Economy Mode is used the factory programming is overridden until midnight of the current day. When the Economy Mode is active, the Economy icon will appear solid in the display window.

ADDITIONAL FEATURES

Inverted Display: The lower display can be inverted for easy viewing inside or outside the spa. Press and hold the Economy key for 2 seconds to toggle between inverted and normal display modes.

Panel Lock: It is possible to lock all of the spaside control keys. Press and hold the Pump 1 key for 5 seconds, “**LocP**” will appear indicating a “Partial” lock of the keys. The Pump 1 & 2, Blower and Light keys will continue to function while the Program, Economy and Temperature set keys will be locked. Continue to hold the Pump 1 key for a total of 10 seconds and “**LocF**” will appear indicating all the keys have been locked. To unlock keys, simply press and hold the Pump 1 key for 5 seconds until “**Uloc**” will appear indicating the spaside has returned to normal operation.

Smart Winter Mode: If the system detects ambient conditions below a preset factory setting, the system will automatically activate the Smart Winter Mode for a period of **24 hours**. In this mode, if a pump has not been powered in the last 2 hours, the system will turn it on for one minute to prevent freezing. The Filter Mode light indicator will flash while the pump is running in this mode. **Note: If you notice the pump coming on every 2 hours. This is the most likely cause. This will continue for a 24-hour period. This is normal and is the Systems protection against freezing.**

Freeze Mode: If the actual spa water temperature drops below a preset factory setting, the pump and heater will be turned on until the spa water has been sufficiently heated to prevent freezing. All functions (except the alarms) will be disabled while the freeze protection is active.

Over Temperature Protection: If the water temperature exceeds 112F at the Temperature sensor 3 flashing dots will appear below the temperature display and the heater as well as all other outputs will shut off. After the water has cooled down power to the spa must be cycled off then on to reset the system. If the spa water temperature does not seem to be elevated, the error indication may have been caused by poor water flow or electrical line interference (thunder storms, voltage surges, etc.). Simply reset and monitor the system.

Power-Up Detection: Upon first powering the system or if a power outage occurs, the display will flash until a key is pressed. This feature also lets the user know there has been a power failure.

ERROR IDENTIFICATION

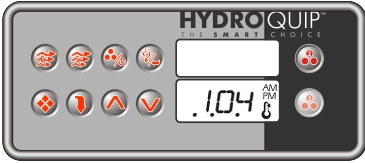

If 3 flashing dots appear below the temperature display an error and a need for service has occurred. **(Contact Your Local Dealer for Service)**

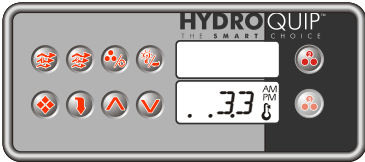

If the actual spa water temperature greatly differs from the displayed temperature or the display reads a constant 33°F, a temperature sensor error and a need for service has occurred. **(Contact Your Local Dealer for Service)**

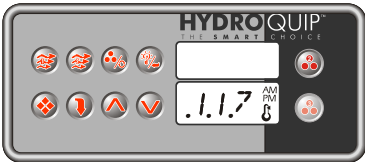

If 3 flashing dots appear below the temperature display and the temperature displayed is 115°F or higher, and over temperature condition and a need for service has occurred. **(Contact Your Local Dealer for Service)**

NOTE: If you notice the pump coming on for seemingly no reason throughout the day, the system may be in "Smart Winter Mode". If you cannot control some functions of the spa be sure to check to see if the Filtration indicator is illuminated. The spa may be in the midst of a filtration cycle. Freeze Protection and Over temperature condition will also limit or disable spa functions.

SPA LIGHT

Your control may contain a high intensity, low voltage light to enhance nighttime use.

This illustration shows how and where to find the bulb for replacement. It also shows the mounted spa light with a replacement (colored) lens. Colored lenses will further the enhancement of the light. Simply snap on or off to change the mood of your spa.

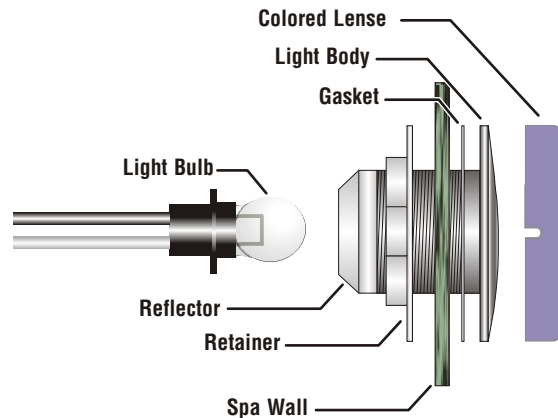

OPERATIONAL CONSIDERATIONS

The following describes situations you may encounter and situations to be aware of.

WARM WEATHER CONDITIONS

Since your spa will normally be expected to maintain warm to hot water to be ready for your use, a great deal of attention has been directed to the **energy conservation** detail of insulation so as to keep electrical costs down. This **energy conservation efficiency** may be achieved by extensive insulation of the skirt, plumbing and spa shell, and in some climates full foam insulation may have been provided.

This **energy conservation** feature may cause an inconvenience during warmer times of the year. During warm periods of the year, the temperature within the equipment compartment can elevate to a point that the pump will automatically turn off for a short period of time (15-30 minutes) to allow the pump to cool down before automatically restarting. This cool down feature will not harm your spa but serves only to protect the pump from damage and as an indicator that it is too hot. To minimize this occurrence, refrain from using your Hydrotherapy Jets for prolonged periods of time during warm seasons.

The jet pump chosen for your spa has been specifically sized for *maximum performance*

FILTRATION

Please refer to your Spa Manufacturer's owner's manual regarding the operation, maintenance and cleaning of your filtration system.

Dirty or clogged filters can cause flow restrictions and you may experience difficulty in reaching and/or maintaining desired heat levels.

FREEZE PROTECTION & WINTERIZING

When freezing weather and/or power losses are expected, contact your local spa dealer for freeze protection or winterizing recommendations for both the spa and the equipment system. Freeze related damage is not covered by the Hydro-Quip warranty.

CHEMICAL WATER TREATMENT

Your dealer is familiar with local water conditions and which chemicals are compatible with the water and are designed specifically for your spa. This is the best person to advise you on proper water quality management.

The one thing you can do to insure years of trouble free equipment operation is to maintain proper water chemistry.

Two basic goals of the chemical water treatment are sanitizing and balancing the water.

Sanitizing simply means keeping the water free from living microorganisms including algae, bacteria and viruses. The current most popular chemicals for sanitizing include chlorine, bromine and ozone.

Balancing water means establishing a balance among pH, total alkalinity and total hardness. Water that is unbalanced can corrode the spa and it's support equipment or leave deposits of minerals. Properly balanced water is essential to allow the sanitizing chemical to work effectively. There are numerous chemical additives to help you in controlling pH, total hardness and total alkalinity. **NEVER** use softened water when filling your spa. Softened water is extremely corrosive to the metal parts of the spa equipment and may lead to an unforeseen failure.

Sometimes, despite your most diligent efforts, your water may become too far out of balance to be managed chemically. At this point it is probably better to drain and clean the spa and start over with fresh water.

Equipment failure caused by improper water chemistry will not be covered under warranty.

TROUBLESHOOTING

The following describes situations and possible solutions to common problems you may encounter as a spa owner.

NOTHING OPERATES

Main Breaker is OFF - *Set to On.*

Sub-Panel Breaker Off - *Set to On.*

Equipment GFCI Off - *Set to On.*

Power switch in Off position - *Set to On.*

Components not plugged in - *Plug in components.*

Power cord not plugged in - *Plug in power cord.*

Over or High Temperature Protection On - *Refer to "Error Identification"*

NO, LOW OR SURGING WATER FLOW

Air Lock in Plumbing System - "Bleed" the system.

Restricted Flow - *Insure that the water shut-off valves are open and that suction fittings are not blocked by debris.*

Dirty Filter - *Clean or replace filter.*

Low Water Level - *Increase water level to recommended level.*

NO LOW SPEED PUMP OPERATION

Low Level Programming Incorrect - Contact your local dealer.

Over or High Temperature Protection On - *Turn power to spa off then on again to reset.*

Pump Not Plugged-In - *Plug in the Pump.*

NO PUMP OR BLOWER OPERATION

Pump or Blower Not Plugged-In - *Plug in the Blower or Pump.*

Over or High Temperature Protection On - *Turn power to spa off then on again to reset.*

NO THERAPY JET OPERATION

Water Shut-Off Valves are Closed - *Open Shut-Off valves.*

Dirty Filter - *Clean or replace filter.*

Jets Not Properly Adjusted - *Adjust Jets properly.*

Diverter Valve Not Properly Adjusted - *Adjust diverter valve properly.*

Thermal Overload Tripping - *Check for restricted flow of water.*

Over or High Temperature Protection On - *Turn power to spa off then on again to reset.*

WATER LEAKS

Spa Overfilled - *Adjust water level.*

Too Many People in the Spa - *Adjust water level.*

Drain-Valve Left Open - *Close drain valve.*

Couplings or Unions Loose - *Tighten or contact your local dealer.*

Pump Seal Leaking - *Contact your local dealer.*

Plumbing / Connections Leaking - *Contact your local dealer.*

Water Leaking from Spaside Control - *Contact your local dealer.*

Water in Air Blower Plumbing - *Contact your local dealer.*

NO HEAT

Temperature Not Set Correctly - *Adjust Set Point.*

Over or High Temperature Protection On - *Turn power to spa off then on again to reset.*

Current Limiting On - *120V Systems will not heat if High Speed or Blower is on. Contact your local dealer.*

No Power - *Reset breaker at service panel.*

Low Water Flow - *Clean or Replace filter.*

Pressure Switch Not Adjusted Properly - *Contact a qualified technician.*

HIGH HEAT

Temperature Sensor Not in Dry-Well - *Place sensor in dry-well.*

Temperature Set Too High - *Adjust Set Point.*

High Ambient Temperature - *Remove spa cover.*

GFCI TRIPS OCCASIONALLY

Lightning or Electrical Storm, Power Surge, Extremely Humid Conditions, or Radio Frequency Interference - *Reset GFCI.*

NOTE: GFCI must be properly grounded and bonded.

GFCI TRIPS IMMEDIATELY

Defective Component - *Contact a qualified service technician or the factory for assistance.*

NO LIGHT OPERATION

Light Bulb Defective - *Replace bulb or contact your local dealer.*

Reflector has Fallen Off - *Replace deflector or contact your local dealer.*

Light Not Plugged-In - *Plug in the Light.*

SYSTEM DATA LABEL

The system data label is located on the control box. This label is very important and contains information you will need to establish your electrical service. The voltage and amperage ratings are shown on the bottom of the label. Product, Model, Serial and Code numbers are also shown on the label.

Note: This information will be necessary if you should ever have to request warranty or any other type of service.



HYDROQUIP™
THE **SMART CHOICE™**

ORDER CODE: _____

MODEL: _____

SERIAL: _____

CODE: _____

VOLTS: _____

AMPS: _____

PRODUCT: _____

**REFER TO NEC FOR
BREAKER SIZING**

WARRANTY INFORMATION

To all original purchasers, **HYDRO**QUIP warrants its products to be free from defects in material and workmanship for a period of one year from the date of purchase.

HYDROQUIP will repair or replace the part, which in our opinion, is defective.

This warranty excludes damage as a result of: normal wear, freezing, low voltage, chemical abuse, accident, negligence, alteration, improper installation, use or care.

To obtain warranty service, return defective products within the warranty period to **HYDRO**QUIP.

Purchaser is responsible for removal or reinstallation labor, freight charges, or any other such costs incurred in obtaining warranty service.

HYDROQUIP assumes no responsibility for incidental or consequential damages. Some states do not allow the exclusion of incidental or consequential damages, so the above limitations and exclusions may not apply to you. This warranty gives you specific legal rights and you may also have other rights, which vary from state to state.

**THE SPA DEALER MAY PROVIDE A DIFFERENT WARRANTY,
CONTACT YOUR SPA DEALER FOR DETAILS**

NOTES

Use this section to jot down any information you may need at a later date.

Dealer: _____ **Date of Install:** _____

Contact: _____ **Phone:** _____

Address: _____

City: _____ **State:** ____ **Zip:** _____

Notes: _____



HYDROQUIPTM

13345 Estelle Street • Corona, CA 92879-1881

Email: hq@hydroquip.com • Internet: <http://www.hydroquip.com/>

Telephone: 909.273.7575 • Fax: 800.332.7190