



Owner's Manual

2009

Rev 01.28.09



TABLE OF CONTENTS

Important Safety Instructions	2
Location and Installation	4
Spa Set Up	5
240 Volt to 120 Volt Wiring Conversion	7
GFCI Load Center Wiring	8
Spa Operation	9
Winterizing, Ozone	10
Water Care, Consumer Notice	11
Spa Care and Maintenance	12
Troubleshooting	13
Control Panel Instructions (Gecko in.k200)	14
Troubleshooting Topside Control Error Codes	15
Spa and Dealer Information	16
Warranty	17

IMPORTANT SAFETY INSTRUCTIONS

When installing and using this electrical equipment, basic safety precautions should always be followed, including the following:

1. READ AND FOLLOW ALL INSTRUCTIONS

1. DANGER - Risk of Accidental Drowning. Extreme caution must be exercised to prevent unauthorized access by children. To avoid accidents, ensure that children cannot use this spa unless they are supervised at all times.
2. DANGER - Risk of Injury. The suction fittings in this spa are sized to match the specific water flow created by the pump. Should the need arise to replace the suction fittings or the pump, be sure that the flow rates are compatible. Never operate the spa if the suction fittings are broken or missing. Never replace a suction fitting with one rated less than the flow rate marked on the original fitting.
3. DANGER - Risk of Electric Shock. Install at least 5 feet (1.52 m) from all metal surfaces. As an alternative, a spa may be installed within 5 feet of metal surfaces if each metal surface is permanently connected by a minimum No. 8 AWG (8.4 mm²) solid copper conductor to the wire connector on the terminal box that is provided for this purpose.
4. DANGER - Risk of Electric Shock. Do not permit any electric appliance, such as a light, telephone, radio, or television, within 5 feet (1.52 m) of a spa.
5. WARNING – To reduce the risk of injury, the water in the spa should never exceed 104°F (40°C). Water temperatures between 100°F (38°C) and 104°F (40°C) are considered safe for a healthy adult for a 10-to-15 minute time period. Lower water temperatures are recommend for extended use (exceeding 10-15 minutes) and for younger adults/children.
6. WARNING – To reduce the risk of injury, do not permit children to use this product unless they are closely supervised at all times.
7. A wire connector is provided on this unit to connect a minimum No. 8 AWG (8.4mm²) solid copper conductor between this unit and any metal equipment, metal enclosures of electrical equipment, metal water pipe, or conduit within 5 feet (1.52 m) of the unit.
8. Excessive water temperatures have a high potential for causing fetal damage during pregnancy. Pregnant women should limit spa water temperatures to 100°F (38°C) and only use the spa under the direction of a licensed physician.
9. The use of alcohol, drugs, or medication before or during spa use may lead to unconsciousness with the possibility of drowning.
10. Persons taking medication should consult a licensed physician before entering the spa.
11. Persons suffering from obesity or with a medical history of heart disease, low or high blood pressure, circulatory system problems, or diabetes should consult a licensed physician before entering the spa.
12. CAUSES, SYMPTOMS AND EFFECTS OF HYPERTHERMIA - Hyperthermia occurs when the internal temperature of the body reaches a level several degrees above the normal body temperature of 98.6° F. The symptoms of hyperthermia include an increase in the internal temperature of the body, dizziness, lethargy, drowsiness, and fainting. The effects of hyperthermia include (1) failure to perceive heat, (2) failure to recognize the need to exit spa, (3) unawareness of impending hazard, (4) fetal damage in pregnant women, (5) physical inability to exit the spa, (6) unconsciousness resulting in the danger of drowning.
13. The use of alcohol, drugs, or medication can greatly increase the risk of fatal hyperthermia.
14. During winter months where the temperature is consistently below freezing, check your spa periodically to ensure that it is operating correctly and that the power to the spa has not been interrupted as to protect the water lines from freezing.
15. Do not use your spa alone.

17. People with infectious diseases should not use the spa.
18. To avoid injury, use care when entering or exiting the spa.
19. Do not use the spa immediately following strenuous exercise.
20. Maintain proper water chemistry in accordance to manufacturers' instruction.

ELECTRICAL SAFETY INSTRUCTIONS

1. Read & follow all safety instructions.
2. A green colored terminal or a terminal marked G, GR, Ground, Grounding, or the international symbol is located inside the supply terminal box or compartment. To reduce the risk of electric shock, this terminal must be connected to the grounding means provided in the electric supply panel with a continuous copper equivalent in size to the circuit conductors supplying this equipment.
3. The equipment must be provided with a ground fault circuit interrupter located in the disconnect switch, as installed by a licensed electrician.
4. The electrical service panel should be equipped with a 50-amp switch.
5. The electrical supply for the spa must include a suitably rated switch or circuit breaker to open all ungrounded supply conductors, to comply with section 422-30 of the National Electrical Code, ANSI/NFPA 70-2002. The disconnecting means must be readily accessible to the spa occupant, but must not be within 5 feet (1.52 m) of the spa.
6. All field-installed metal components such as rails, ladders, drains or other similar hardware within 3 meters of the spa shall be bonded to the equipment grounding bus with copper wire conductors not smaller than No. 6 AWG.
7. For units intended for use other than single family dwellings, a clearly labeled emergency switch shall be provided as part of the installation. The switch shall be readily accessible to the occupants and shall be installed at least 5 feet (1.52 m) away, adjacent to, and within sight of, the unit
8. **WARNING:** Improper electrical connections or conductor sizing may cause the equipment module to operate improperly, create the potential for an electrical hazard, and may void the warranty.
9. **CAUTION:** Use only approved pressure-type wire splicing lugs or connectors suitable for the size and type of wiring used.

If your hot tub is equipped with audio components, the following instructions also apply:

1. **CAUTION - Risk of Electric Shock.** Do not leave component access panel open.
2. **CAUTION - Risk of Electric Shock.** Replace components only with identical components.
3. **CAUTION -** Do not operate the audio components while inside the spa.
4. **WARNING - Prevent Electrocution.** Do not connect any auxiliary components (for example cable, additional speakers, headphones, additional audio/video components, etc.) to the system.
5. These units are not provided with an outdoor antennae; when provided, it should be installed in accordance with Article 810 of the National Electrical Code, ANSI/NFPA 70.
6. Do not service this product yourself as opening or removing covers may expose you to dangerous voltage or other risk of injury. Refer all servicing to qualified service personnel.
7. If the power supply connections or power supply cord(s) are damaged; if water is entering the audio equipment compartment area; if the protective shields or barriers are showing signs of deterioration; or if there are signs of other potential damage to the unit, turn off the unit at the disconnect switch and refer servicing to qualified service personnel.
8. This unit should be subjected to periodic routine maintenance (for example, once every 3 months) to make sure that the unit is operating properly.
9. Replace damaged cord immediately.
10. Do not bury electrical cables or cords.

LOCATION AND INSTALLATION

Your spa has been conveniently designed for use in either an indoor or outdoor setting. While selecting an appropriate location for your spa, there are important things to consider.

Indoor Considerations

1. Walls, ceiling, flooring, and/or hardwood must be able to withstand high humidity. Just like in your bathroom, an exhaust fan would be a good idea.
2. Spa Chemicals in the air may corrode certain metals in your home.
3. A self-draining floor is a great way to ease any worries about spilled water.
4. Spas must be accessible at all times to permit servicing if needed. Cost associated with the removal of walls, pulling a spa out of an enclosed area, etc. are not the responsibility of the manufacturer. All costs associated with these types of items will be the sole responsibility of the homeowner.
5. Remember that you'll need extra space to store the cover when it is removed. When using our handy cover-lift device, you should allow for an extra 16" of clearance behind the spa.
6. The spa must be placed on a solid, flat, and level surface that does not move or shake.
7. You should consult with a builder or engineer to determine if your floor will support the spa weight. Remember, you must allow for the spa, water, and people in your total weight calculations.
8. Be sure your spa is secure from access by young children. We offer a locking spa cover, but we also suggest keeping the spa room locked and off limits to children.

Outdoor Considerations

1. Place your spa on a solid, flat, and level surface. We recommend a 4" thick reinforced concrete pad as the best surface. Dirt, sand, concrete pavers, paver stones, etc. are not acceptable surfaces for your spa and these surfaces will void all warranty claims.
2. Keep in mind natural elements such as wind, sun, falling leaves, etc. Also consider lighting, visibility from the house, and accessibility.
3. We recommend that you locate your spa in a locked fenced-in area to prevent access to the spa by children.
4. It is a good idea to have a contractor review your proposed site to see that there are no support problems. There are often local ordinances that need to be met for spa use.

Indoor or Outdoor Considerations

1. When installing the spa, provide for adequate drainage to prevent water from entering the equipment module area.
2. When installing the spa, enable access to the equipment compartment.
3. Never locate light switches or other electrical components within reach from inside your spa. The equipment module must remain protected by the skirting of the spa.

Wherever you locate your spa, you will need to have access to water in order to fill it. Also, you will need to be able to drain your spa periodically. Since your spa water will likely have chemicals in it, you won't want to drain your spa on the lawn or into a garden. Be sure you can reach a garden hose from the spa to where you plan to drain the water. Never let water get on the equipment module that is located in the door opening of your spa.

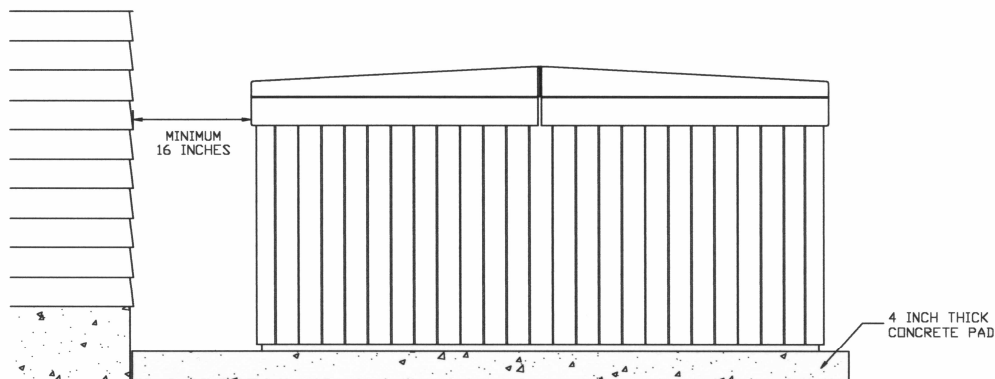

RECOMMENDED SUPPORT

SPA SET UP

General Procedures

This section covers the installation of your spa. All electrical steps must be performed by a licensed electrician. The spa must be connected to a proper power supply and meet all National Electrical Code (N.E.C.) and local code requirements. The connection must include the conductors necessary for operation and bonding, as required by N.E.C.

1. Remove the spa from its shipping container and retain all safety, operation, and warranty information.
2. Position the spa on a flat, level surface such as concrete, or a wood deck which provides adequate drainage.
3. Position the spa at least 5 feet from all metal surfaces unless each metal surface is permanently connected to a bonding wire, as indicated in step 4.
4. The spa may be installed within 5 feet of metal surfaces as follows:
 - Installation must be in accordance with Article 680-(40-44) of the National Electrical Code, ANSI/NFPA 70-2002.
 - Each metal surface must be permanently connected to a bonding wire which is attached to a pressure wire connector provided for that purpose.
 - The pressure wire connector is located on the equipment system control enclosure.
 - The bonding wire must be at least No. 8 AWG (8.4 mm²) solid copper wire, in accordance with article 680-43E.
 - The bonding wire must be attached to the pressure wire connector and all metal equipment, metal enclosures of electrical equipment, metal water pipe, or conduit within 5 feet of the spa.

240V Systems

1. Install a 50-amp, switch in the electrical service panel.
2. The electrical supply for the spa must include a GFCI to shut off the power supply (to comply with section 422-30 of the National Electrical Code, ANSI/NFPA 70-2002). This disconnecting means must be readily accessible to the spa occupant, **however it must not be within 5 feet of the spa** (see diagram).

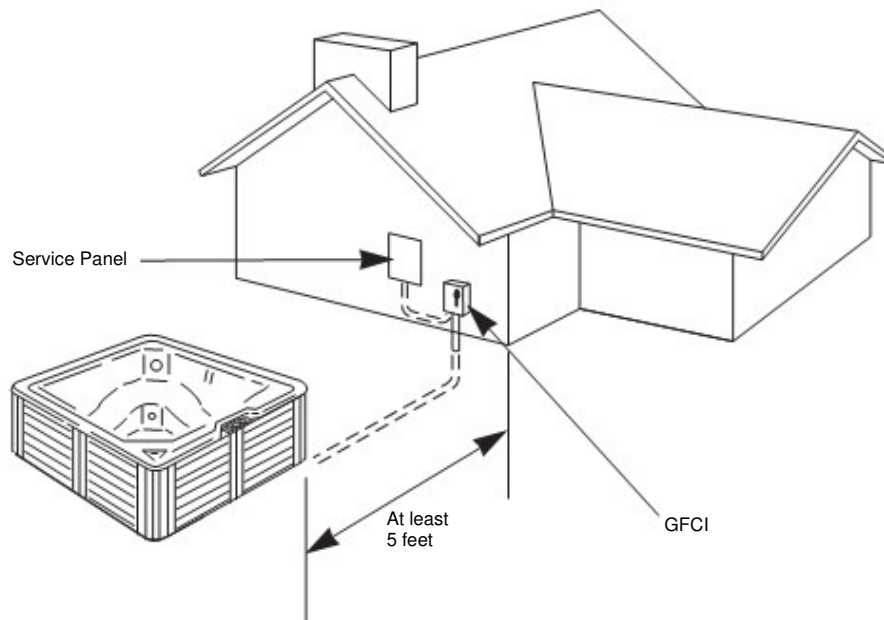

240V Systems
Continued

3. Pull four copper current carrying conductors (one each: black, red, white, green). Use either No. 6 AWG 60° C, No. 8 AWG 75° C, or No. 8 AWG 90° C wire, if spa is 50 feet or less away from its power supply.
4. Reposition the spa at its final location and route the flexible conduit.
5. Using a 1" conduit connector at the end of the flexible conduit, route wires through an entrance hole cut by your electrician in the control enclosure, and attach the conduit connector to the control enclosure.
6. Attach power wires to the terminal block. See 240V wiring diagram inside the control enclosure cover. Attach the wires as follows and shown in graphic below:

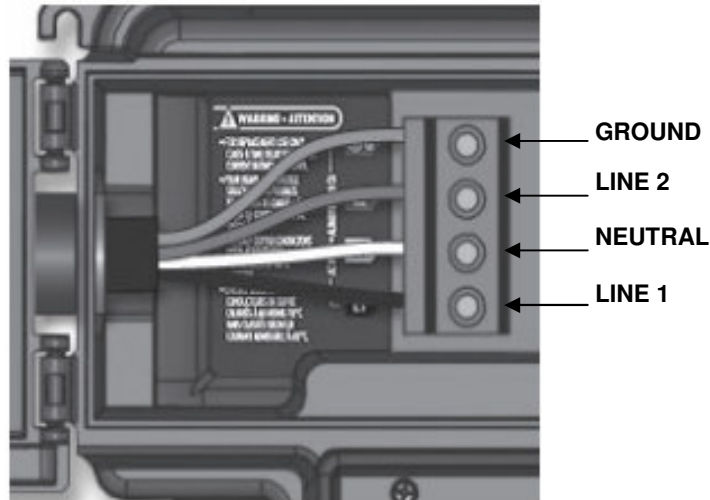

7. Complete the conductor connections at the power supply panel.
8. Do *not* turn power on until instructed to do so in the “Filling Your Spa” section.

Filling Your Spa

Once the electric power has been connected, check the following while the power is OFF:

1. Be sure all fittings to the support system are tight. Hand tighten only!
2. Be sure the drain valve is closed.
3. Your spa is equipped with 2 or 4 push/pull valves. There is one located before the suction side of the pump and one located adjacent to the discharge side of your heater. If you have a secondary pump, there will be two valves for this pump as well. Pull the push/pull valves OUT so they are open.
4. Using a garden hose, fill with water to 2-4" above the skim filter. Always fill your spa with hard (not softened) water. Do not over-fill. After the spa is filled, remove the garden hose.
5. Check the equipment module area for water leaks. If there is water dripping, it is probably a loose connection at the equipment module. You should re-check the tightness of the fittings and placement of the "O"-rings. If you cannot locate the source of the water leak, contact your authorized service dealer.
6. Check that the filter is positioned in the skim/filter system.
7. Activate the power to your spa. Refer to the “Control Panel Instruction” section of this manual.

240v TO 120v WIRING CONVERSION FOR IN.XE SPA PACKS

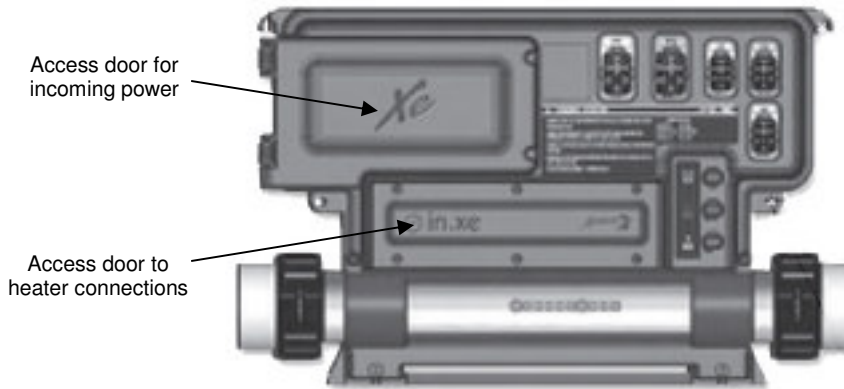

Figure 1

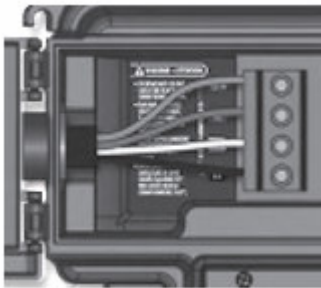

Figure 2

For 240 VAC (4 wires)

Correct wiring of the electrical service box, GFCI, and pack terminal block is essential. Call an electrician if necessary.

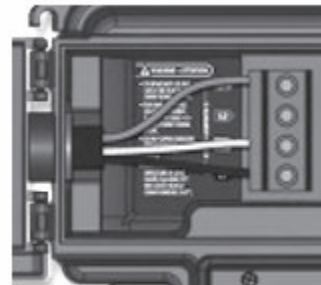

Figure 3

For 120 VAC (*3 wires)

*If connected to a 3 wire system, no 240 VAC component will work.

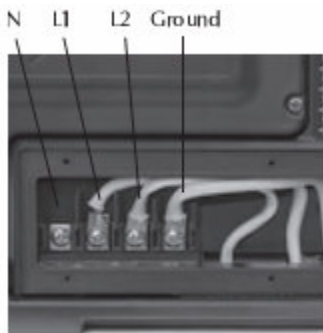

Figure 4

Connections for 240v heater

The heater is factory configured 240v / 4kW, but it can be converted to a dedicated 120v / 1kW by simply switching a cable on the connection port.



Figure 5

Connections for 120v heater

In order to properly configure the heater to run on 120v, you must make sure to remove the L1 wire and connect it to the Neutral terminal post on the connection port.

INSTRUCTIONS FOR CONVERTING HEATER FROM 240V TO 120V

These instructions pertain only to those spas furnished with a factory installed Gecko in.xe spa pack (see figure 1). It is possible to convert these systems to 120 volt operation in order to meet your installation requirements. The following instructions must be carefully followed.

1. The conversion must be made by a qualified, licensed electrician in accordance with national and local electrical codes.
2. Permanently connected units must be protected with a ground fault circuit interrupter (GFCI).
3. Unplug or disconnect power to the spa and remove the wiring or power cord from the power input terminals (figure 2).
4. Locate the access door for the heater connections (figure 1) and remove all six screws.
5. Unscrew the L1 wire from the terminal post (figure 4), then reconnect it to the Neutral terminal post (figure 5).
6. Replace the heater access door using all six screws.

GFCI LOAD CENTER WIRING

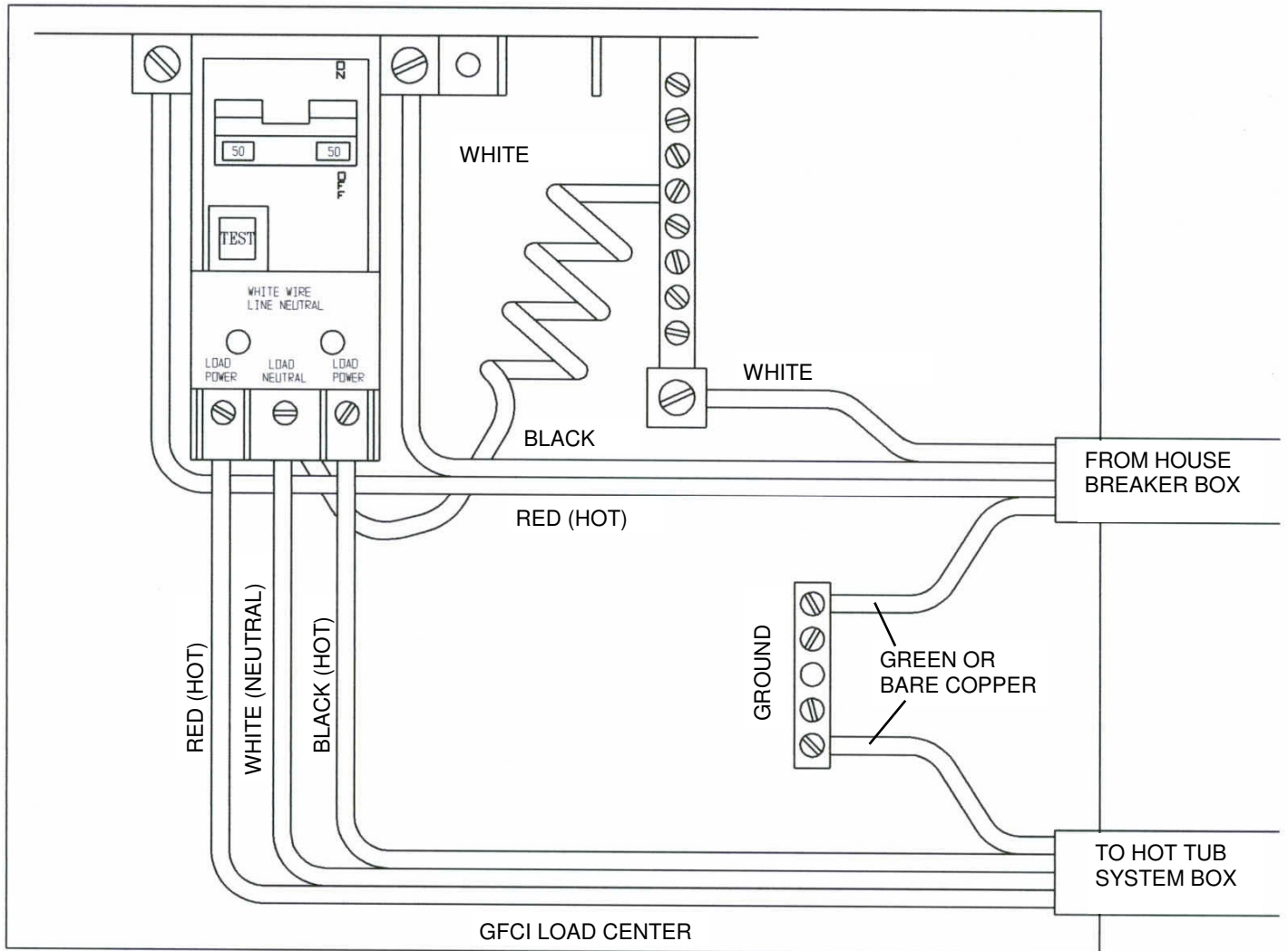

NOTE:

The white neutral wire from the back of the GFCI MUST be connected to an incoming line neutral. The internal mechanism of the GFCI requires this neutral connection. The GFCI will not work without it.

IMPORTANT NOTE:

Installation of this GFCI-Circuit Breaker, including ampere sizing and selection of conductor size and type, must be accomplished by a qualified electrician in accordance with the National Electrical Code, or the Canadian Electrical Code, and all federal, state and local codes and regulations in effect at the time of installation.

SPA OPERATION

Your spa comes equipped with a variety of jets. Some of the jets allow you to control the amount of water flow by rotating the face of the jet. Turning the face clockwise will reduce the water flow from the jet and turning it counterclockwise will increase the water flow.

Ozone Jet

In the foot well of your spa there is a jet which allows ozone to be drawn into your spa when your spa is equipped with an ozone unit. With an ozonator installed, there will be a steady stream of small air bubbles coming from the ozone jet whenever the spa pump is in operation. See your dealer for an optional ozone unit.



Interchangeable Jet Faces

The jet faces of the various styles of jets can be easily interchanged with others of the same size. This allows you to customize your spa massage therapy. Each style of jet varies in intensity or sensation. To remove the jet face to relocate it, simply turn the outer ring counterclockwise past the stop point. This disengages the jet, then gently pull on the outside ring of the jet. The jet insert will pull away from the spa. Follow the same procedure with another jet. To reinstall, simply push the jet insert back into the jet cavity until it stops, then rotate the jet clockwise until it snaps into place. Water flow through these jets can be controlled by turning the outside face of the jet. Turning the trim ring clockwise will reduce the water flow from the jet and turning it counterclockwise will increase the water flow.



2" Directional Jet



3" Pulsator Jet



3" Directional Jet



5" Twin Spin Jet

Thermal Spa Cover

It is important that you properly care for your spa cover. Do not sit or stand on the cover, as it will break. Do not let snow build up on your cover. Lock-down tabs are included with your cover and should be used to prevent access to the spa by children. If your spa is located outdoors, it is important that you use the tie down tabs to prevent the wind from lifting the cover off your spa. Periodically clean your cover as described in the maintenance and cleaning instructions provided with the cover. When handling your cover, take care not to drag it over rough surfaces that will scuff or tear the fabric.



Cabinet Care

Natur-all™ panel products are maintenance free products and the only cleaning they require is the rinsing off of debris that has collected on the surface. To remove, simply rinse with water or lightly wash with mild soap and water. Do not use any chemicals since these may etch the surface.

WINTERIZING

If you live in an area where the danger of freezing exists, you must take extra precautions to insure that your spa will operate properly. If you plan to operate your spa throughout the winter, be sure that the thermostat is set to keep the water warm. If you intend on closing down your spa for the winter, you should follow the winterizing procedures listed below:

1. Drain the spa as explained in the "Draining Your Spa" section.
2. Be sure that all water is removed from the spa.
3. Shut off all electrical power at the breaker box.
4. Disconnect the unions from the equipment module to allow the water in the spa lines and equipment module to drain.
5. Remove the drain plug(s) on the pump housing to allow water to drain out of the pump. Replace the drain plug.
6. Remove the filter element from the filter housing and see that the filter housing is dry. If water is left in the filter housing it will freeze and cause the housing to crack.
7. Using a wet/dry shop vacuum, vacuum out each of the lines at the point where you disconnected the unions from the equipment module. Also, put the vacuum hose up against the face of each jet opening to vacuum out any water remaining in their supply lines.
8. Cover your spa with your spa cover and be sure it is locked in place.

WARNING: Failure to maintain the proper chemical levels or properly winterize your spa may cause extensive damage to components. Damage to components or the spa shell itself resulting from improper chemical maintenance or improper winterization will NOT be covered under warranty.

OZONE

The optional ozonator is a unit that contains an ultra-violet light. When the unit is activated, ozone is generated which is drawn into the spa via the ozone jet. The ozone gas appears as tiny bubbles that come from the ozone jet which is located near the front of the spa. The ozone coming into your spa purifies the water without the skin irritation and chemical smell that can occur with the use of chemicals. When installed according to instruction, the ozone unit operates when the equipment module is in the filtering mode.

Ozone is a gas which occurs in nature. The ultraviolet (UV) radiation from the sun creates ozone photo-chemically in the outer limits of the atmosphere. Ozone is also created near ground level by lightning during electrical storms. Ozone generators simulate the short wavelength ultraviolet radiation of the sun with specially designed quartz lamp and ballast systems.

Oxygen molecules (O_2) contained in the air passing across these lamps, are energized and split into single oxygen atoms (O_1). These O_1 's are highly reactive and combined with additional O_2 form Ozone (O_3). This photochemical method of producing ozone is safe and efficient.

Ozone has proven to be a very effective supplement for conventional chemicals to provide cleaner, healthier water and to significantly reduce undesirable chemical by-products.

WATER CARE

Your spa is equipped with what we believe is the finest filtering device available. We call it the Skim/Filter system, and it is one of the few skimmers available which actually skims the water surface. When your spa is operating, watch how the Skim/Filter bobs up and down with the water level. You'll notice a distinct whirlpool being drawn into the system, and floating debris of all sizes will literally "fall" into the unit and be trapped by the filter. It is important that you keep your filter clean, and it is suggested that you check the filter at least once per month and replace it when it becomes loaded with dirt or debris.

Filter Basket and Cartridge Removal and Replacement Procedure

1. Turn off electrical power to the spa.
2. Remove the floating weir and attached basket by rotating it counterclockwise to align the flat tabs on the filter housing flange with the flat areas on the floating weir and basket assembly, then lift out the assembly.
3. Lift the filter cartridge straight up and out of the filter housing, quickly moving it away from the tub to prevent collected debris from falling back into the water.
4. Separate the floating weir from the basket by rotating it counterclockwise to align the notches on the floating weir flange with the tabs on the top of the basket, then simply pull them apart.
5. Clean any accumulated debris from the basket. Avoid hitting the basket against objects to knock debris loose, as this will break the basket.
6. Re-attach the basket to the floating weir.
7. Install a new filter cartridge in the filter housing.
8. Reinstall the floating weir and attached basket assembly.
9. Turn electrical power to your spa back on.



CONSUMER NOTICE

Chemicals

Due to the warm temperatures in your spa, you must properly test and maintain your spa water for health and appearance reasons. Chemical imbalance can cause skin irritations, and dirty water is both unsightly and undesirable to soak in. With little effort you can have clean water for your constant enjoyment. This is attained through the use of spa chemicals, a superb filter system and the optional ozonator. Consult your dealer to set up a proper water treatment program that will work best with the equipment in your spa.

CAUTION: Always follow the water treatment chemical manufacturer's instructions when treating your water. Higher than normal concentrations of certain chemicals can degrade or cause permanent damage to your spa. When introducing chemicals into the water, never pour them directly into the filter.

Be aware that the mineral content of spa water increases from water evaporation and with the addition of algaecidal and sanitizing chemicals. If the mineral concentration of the water becomes too high, the minerals will precipitate and deposit on the spa, in the filter, and on the heater. The water must be changed when the amount of dissolved solids becomes excessive. Algaecidal and sanitizing chemicals are either alkaline or acidic. Sodium and calcium hypochlorite are alkaline. Chlorine gas and practically all other dry chlorine products are acidic. Whichever type of chlorine is used, it is very important that the pH level be checked frequently and maintained between 7.2 and 7.8.

CAUTION: Do NOT store spa or pool chemicals near the equipment module because their corrosive fumes may cause damage. Change the spa water frequently, typically every 3 to 4 months or when the water clarity and cleanliness can no longer be maintained by chemical treatment. It is recommended that the total alkalinity of the spa water be kept from 80 to 100 parts per million (ppm) when sodium or calcium hypochlorites are used, and 100 to 120 ppm when other dry chlorine products are used.

SPA CARE AND MAINTENANCE

Draining Your Spa

Under normal usage, you should change the water in your spa every 3-4 months. Before doing so be sure to turn off all power to the spa, then follow these easy steps to drain the spa:

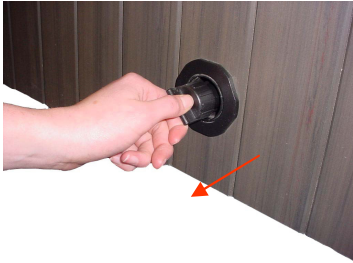

1. Pull the spout out (approximately 2") leaving the exterior end cap on.



2. Rotate the spout assembly counterclockwise until spout stops.



3. After rotating the spout, pull the spout out further until it stops. Rotate drain cap counterclockwise and remove it.



4. Attach a garden hose to drain threads and then push the drain spout back in about half-way to allow water to begin draining from the spa.

Once the tub is drained, replace the drain cap, rotate the spout clockwise until it stops and push it back into the recess. The remaining water in the spa can be scooped or siphoned out and you are now ready to clean the inside surface. Note: It is recommended that you not drain water onto grass or vegetation since chemicals in the spa water may damage them.

Cleaning The Spa Surface

When the spa is empty, you can clean the surface by using a mild, nonabrasive liquid detergent or specially formulated spa cleaner. For general cleaning, any of the following items can be used: Ivory (soap & water solution), Formula 409, Windex, Spic and Span, Scrubbing Bubbles, Fantastik, Simple Green, Pine Sol or any product available at your local spa dealer. For heavy cleaning, you may try one of the following cleaning items, but make sure to remove immediately after use: Soft Scrub (may slightly abrade surface), Bug & Tar Remover or OOPS. Do not use an abrasive brush or cleaning agent, as it will scratch the finish. DO NOT USE any of the following items to clean your tub: Acetone, Goof Off or any cleaners that contain esters, ethers, ketones, aromatic or chlorinated hydrocarbons, Isopropanol (concentrations greater than 25%). If you have stubborn dirt or scum marks at the water line, use a spa cleaner and a scrub pad designed for use on spa surfaces, which are available at your spa dealership. Clean only a small portion of the surface at one time. Use a soft, clean cloth to apply the cleaner. To prevent suds, thoroughly remove all residue from the cleaning agent prior to refilling the spa.

Adjustable Jets

The jet faces on the various 2", 3", and 5" adjustable jets should be removed from time to time to clean off any accumulated hair, dirt deposits, etc. This will insure proper operation of the water flow control feature.

TROUBLESHOOTING

- **Equipment Module Will Not Operate**
 - Make sure the spa control is plugged into the control system of the equipment module.
 - Check the main circuit breaker panel. If the GFCI or circuit breaker has tripped, reset the breaker.
 - If the circuit breaker trips repeatedly, contact your dealer.
 - Turn the circuit breaker, or switch, supplying power to the equipment module OFF then ON.
 - If breaker continues to trip, check with your electrician to be sure the proper amperage breaker was installed.
- **Pump Will Run But There Is No Water Flow**
 - Make sure all valves are in the open position.
 - Make sure the filter is clean.
 - Make sure the suction intake covers are free of debris.
 - Make sure the water level of the spa is at least 2" above the skim filter.
 - Check to make sure all adjustable flow-type jets are turned open.
- **Pump Runs And There Is Water Flow But No Heat**
 - Press the temperature set button to increase temperature. Do NOT expect to feel hot water coming from the jets.
 - Make sure all valves are open to allow full water flow through the system. Limited water flow will NOT build enough pressure to allow the heater to come on.
 - Clean the filter to assure maximum water flow.
- **Pulsating Or Minimal Water Flow In High Speed Mode**
 - Make sure water level of the spa is at least 2" above the skim filter.
 - Be sure jets are turned open (see "Spa Operation" section).
 - Make sure all valves are open.
 - Make sure the filter element is clean.
 - Make sure the suction intake covers are free of debris.
- **Ozone Bubbles Are Not Coming Out Of Ozone Jet**
 - Make sure the lever of the Diverter Valve (if equipped) is not in the center position.
- **Pump Vibrates Excessively**
 - Check for loose screws on equipment module face and bolts attaching equipment module to frame.
 - Make sure spa is not touching or rubbing against anything such as a deck rail, house, etc.
 - Air may be trapped in pump housing. Turn pump off. Slightly loosen the pump unions. With a towel covering the area (water will splash) turn the pump on for 3-5 seconds to bleed air out of pump housing. Turn pump off and tighten the unions. Repeat if necessary.
 - Make sure that the spa has been installed on a properly supported surface.

CONTROL PANEL INSTRUCTIONS FOR GECKO IN.XE SYSTEM

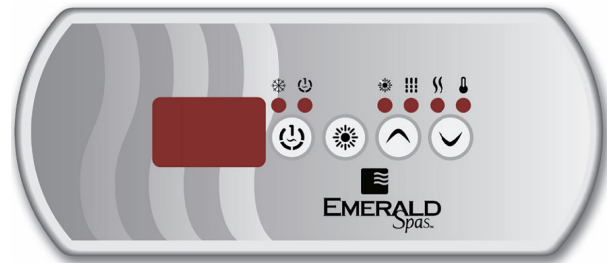

Spa functions

Programming the filter cycles

Key 1 

Press **Key 1** to turn Pump 1 on at low speed. Press a second time to turn pump to high speed (with a dual-speed pump). A third time turns pump off.

 The "Pump 1" indicator lights up when Pump 1 is on. With a dual speed pump, indicator will flash when Pump 1 is on at low speed.

Light Key 

Press **Light** key to turn light on. Press a second time to turn light off. A built-in timer automatically turns light off after 2 hours, unless it has been manually deactivated first.

 The "Light" indicator lights up when light is on.

Up / Down Keys 

Use **Up** or **Down** key to set desired water temperature. The temperature setting will be displayed for 5 seconds to confirm your new selection.

 The "Set Point" icon indicates that the display shows the desired temperature, NOT the current water temperature!

Off Mode

This mode allows you to stop all outputs for 30 minutes to perform a quick spa maintenance.

Press and hold **Key 1** for 5 secs to activate Off Mode. Quick press **Key 1** to reactivate the system before the expiration of the 30-minute delay.

While the Off Mode is engaged, the display will toggle between Off and the water temperature.

To program the filter cycles, you must enter these parameters: duration and frequency. During a filter cycle, Pump 1 runs at high speed for one minute to purge the plumbing. Pump 1 then runs at low speed for the remainder of the cycle.

Setting filter cycle duration

Press and hold **Light** key until the display shows **dx**, with "xx" representing the duration in hours. (Default: 2 hours).

Use **Up** or **Down** key to change setting.

0 = no filtration (not recommended)

Filter cycle frequency

Press **Light** key again. The display will show **Fx**, with "x" representing the number of filter cycles per day (up to 4). (Default: twice a day).

Use **Up** or **Down** key to change settings.

When the desired setting is displayed, press **Light** key to confirm. A filter cycle will start immediately.

 The "Filter" indicator lights up when a filter cycle is on.

Setting temperature display units

Quick press **Light** key again. The display will show either °F or °C.

Use **Up** or **Down** key to change units. Press **Light** key a last time to go back to normal mode.

Water temperature regulation

In a regulation cycle, the system first generates water flow through the heater housing and the plumbing, in order to ensure accurate water temperature readings as well as avoiding heater activation in dry conditions.

After verifying pump activation and taking a water temperature reading if required, the system automatically turns the heater on to reach and maintain water temperature at Set Point.







Smart winter mode

Smart Winter Mode protects your system from the cold by turning pumps on several times a day to prevent water from freezing pipes.

 The "Smart Winter Mode" indicator lights up when the Smart Winter Mode is on.

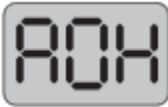
 The "Heater" indicator lights up when the heater is on. It flashes when there is a request for more heat but the heater has not yet started.

TROUBLE SHOOTING / IN.XE ERROR CODES

<u>MESSAGE</u>	<u>MEANING</u>	<u>ACTION REQUIRED</u>
	An internal hardware error has been detected in the in.xe.	Contact your dealer or service provider.
	The system has shut the heater down because the temperature at the heater has reached 119°F (48°C).	Do not enter the water! Remove the spa cover and allow the water to cool down, then shut the power off and power your spa up again to reset the system.
	Temperature inside the spa cabinet is too high, causing the internal temperature in the in.xe to increase above normal limits.	Open spa cabinet panels and wait until error clears.
	The system does not detect any water flow while the primary pump is running.	Check and open water valves. Check for water level. Clean filter. If the problem persists, call your dealer or service supplier.
	A problem is detected with the temperature probe.	Contact your dealer or service supplier.
	The water temperature in the spa has reached 108°F (42°C).	Do not enter the water! Remove the spa cover and allow the water to cool down to a lower temperature. Call your dealer or service supplier if problem persists. ³
	No low level configuration software has been installed into the system.	Contact your dealer or service supplier.

Warning! Shock Hazard! No User Serviceable Parts.

Do not attempt service of this control system. Contact your dealer or service organization for assistance. Follow all owner's manual power connection instructions. Installation must be performed by a licensed electrician and all grounding connections must be properly installed.

Thank You!

We would like to extend our sincere thanks to you for purchasing a new spa.

We hope that you, your family, and friends will experience many enjoyable years of fun and relaxation in your new spa.

Please fill in the following information, it will be very important should you ever have questions or concerns regarding your spa.

Your Dealer Information

Dealership _____
Address _____
City _____ State _____ ZIP _____
Phone _____ Fax _____
E-mail _____
Contact Person _____

Your Spa

Model Purchased _____
Date Purchased _____
Serial Number _____
Colors
 Spa Shell _____
 Cabinet _____
 Cover _____

Notes:

SPA WARRANTY INFORMATION

Emerald Spa Corporation, manufacturer of Emerald Spas and Great Lakes Spas ("Emerald") extends this Limited Warranty **solely** to the original consumer purchaser of a Poly Ethylene Spa manufactured in the U.S.A. or Canada after January 1, 2009.

LIFETIME STRUCTURAL WARRANTY

Emerald warrants (parts and labor) the spa shell against water loss due to defects in the spa shell for the "Lifetime" of the spa shell. For purposes hereof, a spa shell's "Lifetime" shall begin on the date of manufacture and shall terminate on the earlier to occur of (i) the discontinuation of the product line by Emerald, or (ii) ten (10) years from the date of purchase, or (iii) ten (10) years and six (6) months from the date of manufacture. This warranty is subject to the limitations and disclaimers herein.

TWO-YEAR COMPONENT WARRANTY

Emerald warrants (parts and labor) the mechanical equipment, plumbing, fittings, and controls against defects in workmanship for a period not to exceed the lesser of two (2) years from the date of purchase or two (2) years six (6) months from the date of manufacture. Damage caused in whole or in part by improper electrical hook-up or wiring, or by any other cause listed as an exclusion to the warranties herein, voids the warranty. Travel, trip, or mileage costs are not covered under this warranty and service and travel charges may be assessed to the purchaser by the dealer.

EXTENT OF WARRANTY/DISCLAIMERS

These warranties extend **only** to the original "consumer" purchaser of the spa as that term is defined in the Magnuson-Moss Warranty Act, 15 USC Section 101, as amended. These warranties terminate upon: (1) transfer of ownership of the spa; (2) rental of the spa; (3) rental of the premises where the spa is located; or (4) commercial or public use of the spa. Warranty coverage shall not extend for any reason beyond the stated periods. *The warranties as set forth and limited herein are the sole and exclusive warranties made by Emerald and Emerald hereby expressly disclaims any other warranties, express or implied.* **EMERALD HEREBY EXPRESSLY DISCLAIMS THE IMPLIED WARRANTIES OF NON-INFRINGEMENT, MERCHANTABILITY AND FITNESS FOR A PARTICULAR PURPOSE.** EMERALD'S LIABILITY WITH RESPECT TO ITS PRODUCTS SHALL NOT EXCEED THE OBLIGATION TO REPAIR OR REPLACE DEFECTIVE PRODUCT AS EXPRESSLY SET FORTH ABOVE IRRESPECTIVE OF THE THEORY UPON WHICH ANY CLAIM MIGHT BE BASED INCLUDING BREACH OF CONTRACT, WARRANTY, NEGLIGENCE, OR STRICT LIABILITY. UNDER NO CIRCUMSTANCES SHALL EMERALD BE LIABLE FOR SPECIAL, INCIDENTAL, OR CONSEQUENTIAL DAMAGES.

WARRANTY PROCEDURES

In the event of any malfunction or defect covered by any of these warranties, contact the authorized dealer from whom you purchased your spa. All service work must be performed by an authorized dealer or an authorized agent of Emerald. In the event there is not an authorized dealer or repair firm in your area, the spa can be returned pre-paid freight (you pay) to Emerald for evaluation and, if necessary, repair of the defect. Emerald will then ship the spa back to you pre-paid (Emerald pays) upon completion of the repair. In the event the spa needs to be returned to Emerald for repair, contact Emerald in advance at: 4150 East Paris Avenue, Kentwood, Michigan, 49512, phone number: (800) 766.7727, for packaging and shipping instructions. In addition, Emerald reserves the right to inspect or designate a person to inspect any part that is claimed to be defective and covered by this warranty. For any warranty service of components, Emerald reserves the right to choose at its option repair of the problem or a replacement of the defective component. You are responsible to provide adequate access to the spa, equipment, and plumbing. Emerald, its dealers or agents will not perform service on spas where conditions are unclear, unsafe or potentially unhealthy due to abuse, neglect, or improper maintenance. With regard to spa surface warranty repairs, cracks will be repaired so as to prevent damage to or leakage from the spa shell. No warranty is made that the color or texture of the repair will match the original surface. Emerald reserves the right to substitute a part or component of equivalent value, either new or reconditioned, and any such repair or replacement shall assume as its warranty only the remaining portion of the warranty on the original product. Travel, trip, and mileage costs are not covered under these warranties and these charges may be assessed to you. Emerald dealers shall have the right to add additional surcharges for their services which are not covered by these warranties. Any party making a claim hereunder must establish by dated sales slip, invoice or installation receipt the date of original purchase and the fact that claimant is the original purchaser and that the spa is at the original installation location. Transportation costs incurred to and from Emerald for replacement spa, spa shell, plumbing, power pack or any part related to the spa are the responsibility of the purchaser. All costs for the removal and re-installation of the spa, spa shell or power pack are the responsibility of the purchaser.

ACTS INVALIDATING WARRANTIES

These warranties shall be null and void if the spa has been subject to alteration, misuse or abuse (or is used in manner that is not consistent with the product specifications or for which it is not designed) or if any repairs to the spa are attempted by anyone other than an authorized representative of Emerald. Alteration shall include but is not limited to any component or plumbing change, electrical conversion, or the addition of any non-approved sanitation or water purification device or heating system, which contributes to a component or unit failure, or unsafe operation of the system. **CORROSION OR DEGRADATION TO THE SPA SHELL, SURFACE, FITTINGS, STAINLESS ACCENTS, ELECTRONICS, PUMP AND ALL OTHER COMPONENTS THAT ARE CAUSED BY IMPROPER USE OF CHEMICALS AND/OR WATER TREATMENT ARE NOT COVERED UNDER THESE WARRANTIES.** Damages caused by the following are not covered under these warranties: transportation or installation by third parties; operation of the spa at water temperatures outside the range of 50 degrees F. to 104 degrees F.; dirty, clogged or calcified filter cartridges; a defective support system (a solid, flat, level surface is required); harsh chemicals which are not recommended by the plastic manufacturer which come into contact with the spa surface; allowing undissolved spa sanitizing chemicals to come into contact with the spa surface; improper water chemistry maintenance; allowing the spa to remain uncovered in direct sunlight; freezing conditions; moving or relocating the spa; failure of an inadequate pad, platform, deck or other support structure; improper electrical hook-up or wiring; and acts of God or third parties or other damages caused to the spa which are outside the control of Emerald.

[Spa Warranty Information Continued On Next Page]

SPA WARRANTY INFORMATION — [Continued]

LIMITATIONS OF LIABILITY/EXCLUSIONS

THESE WARRANTIES DO NOT APPLY TO PARTS WHICH ARE NOT MANUFACTURED BY EMERALD AND SHALL NOT APPLY TO ANY ITEMS INSTALLED IN OR ATTACHED TO THE SPA AFTER THE DATE OF MANUFACTURE OR TO OPTIONAL PARTS OR SYSTEMS WHICH ARE PURCHASED FOR INCLUSION ON OR IN THE SPA. EMERALD SHALL HAVE NO RESPONSIBILITY TO AID IN THE ENFORCEMENT OF ANY WARRANTIES AGAINST MANUFACTURERS OF SUCH ITEMS, PARTS, SYSTEMS OR OPTIONS. Optional Parts include, without limitation, ozone generator, all audio systems, and LED lighting. Emerald shall not be liable for loss of use of the spa or other incidental or consequential costs, expenses or damages, which include but are not limited to, water and/or sewage costs, water damage to surrounding areas, rooms or furnishings, the removal of or reinstallation of a wall, deck or other fixture, water leakage, costs of shipping or packaging, applicable taxes, or the payment of any costs or expenses of disassembly, removal, or reinstallation of the spa or any part. Pump shaft seal parts are warranted 2 years (unless otherwise excluded as described above) from initial start up of spa and labor is not included on such parts notwithstanding anything above to the contrary. The stainless steel escutcheon on the stainless steel jet option, fuses, light bulbs, spa pillows, spa cover, cover accessories and o-rings are not covered under these warranties. Under no circumstances shall Emerald or its representatives be held liable for injury to any person or damage to any property, however arising, even if caused by Emerald or its representatives' negligence. Some states do not allow limitation on how long an implied warranty lasts, and some states do not allow the exclusion or limitation of incidental or consequential damages, so these limitations or exclusions may not apply to you. These warranties give you specific legal rights, and you may also have other rights, which vary from state to state. No distributor, salesperson, dealer, retailer, or other representative of Emerald other than its President has the authority to alter or change these warranties, which changes must be in writing signed by such President. The warranties herein shall be in lieu of, and not in addition to, any other rights and remedies which might be otherwise available to purchaser.