

# *Owner's Manual*

*300, 400, and 600 Series*



*2003*

## Copyrights and Trademarks

©Copyright 2003MAAX Spas (Arizona), Inc.. All rights reserved. No parts of this publication may be reproduced, stored in a retrieval system, or transmitted, in any form or by any means (electronic, mechanical, photocopying, recording or otherwise), without prior written permission.

Horizon™, Spectrum™, California Cooperage®, Journey™, Powerworks™, Comfort Collar™, Thermo-Lock™, Foot Relief Zone™, CleanZone™, DuraMaax™, and GRIP™ are registered trademarks of Maax Spas.

### Disclaimer:

The information in this manual is accurate to the best of MAAX Spas (Arizona), Inc.'s knowledge. However, MAAX Spas (Arizona), Inc. assumes no responsibility for errors or omissions. Nor is any liability assumed for damages resulting from use of the information contained herein.

Congratulations on your purchase of a Coleman® Spa. Your Owner's Manual provides installation, operation and maintenance instructions. Please review it and keep it for future reference.

## Save These Instructions

### Owner's Record Information

Date Purchased \_\_\_\_\_

Purchased From \_\_\_\_\_

Phone Number \_\_\_\_\_

Installed By \_\_\_\_\_

Serial Number \_\_\_\_\_ Model \_\_\_\_\_

# IMPORTANT SAFETY WARNINGS

**NOTE:** When installing and using this equipment, basic safety precautions should always be taken to reduce the risk of electrical shock, to ensure safe usage, and to safeguard the user's health.

(1) **Read and Follow ALL Instructions!!**

(2) **Ground All Metal and Electrical Equipment!**

(3) A green colored terminal or a terminal marked G, GR, Ground, Grounding, or the international symbol\*  is located inside the supply terminal box or compartment. This terminal must be connected to the grounding means provided in the electric supply service panel, using a continuous copper wire equivalent in size to the circuit conductors supplying this equipment.

*\*IEC Publication 417, Symbol 5019.*

(4) At least two lugs marked "BONDING LUGS" are provided on the external surface or on the inside of the supply terminal box or compartment. Connect the local common bonding grid (household ground) in the area of the hot tub or spa to these terminals, using an insulated or bare copper conductor not smaller than No. 6 AWG.

(5) All field-installed metal components such as rails, ladders, drains or similar hardware located within 5 ft. of the spa or hot tub shall be bonded to the equipment grounding bus with copper conductors not smaller than No. 6 AWG.

(6) **SAVE THESE INSTRUCTIONS.**

**WARNING:** Children should not use spas or hot tubs without adult supervision

and

**AVERTISSEMENT:** Ne pas laisser les enfants utilis-

er une cuve de relaxation sans surveillance

**WARNING:** Do not use spas or hot tubs unless all suction guards are installed to prevent body and hair entrapment

and

**AVERTISSEMENT:** Pour éviter que les cheveux ou une partie du corps puissent être aspirés, ne pas utiliser une cuve de relaxation si les grilles de prise d'aspiration ne sont pas toutes en place

**WARNING:** People using medications and/or having an adverse medical history should consult a physician before using a spa or hot tub

**AVERTISSEMENT:** Les personnes qui prennent des médicaments ou ont des problèmes de santé devraient consulter un médecin avant d'utiliser une cuve de relaxation

**WARNING:** People with infectious diseases should not use a spa or hot tub

**AVERTISSEMENT:** Les personnes atteintes de maladies infectieuses ne devraient pas utiliser une cuve de relaxation

**WARNING:** To avoid injury exercise care when entering or exiting the spa or hot tub

**AVERTISSEMENT:** Pour éviter des blessures, user de prudence en entrant dans une cuve de relaxation et en sortant

**WARNING:** Do not use drugs or alcohol before or during the use of a spa or hot tub to avoid unconsciousness and possible drowning

**AVERTISSEMENT:** Pour éviter l'évanouissement et la noyade éventuelle, ne prendre ni drogue ni alcool avant d'utiliser une cuve de relaxation ni quand on s'y trouve

**WARNING:** Pregnant, or possibly pregnant, women should consult a physician before using a spa or hot tub

and

**AVERTISSEMENT:** Les femmes enceintes, que leur grossesse soit confirmée ou non, devraient consulter un médecin avant d'utiliser une cuve de relaxation.

**WARNING:** Water temperature in excess of 100°F (38° C) may be injurious to your health and

**AVERTISSEMENT:** Il peut être dangereux pour la santé de se plonger dans de l'eau à plus de 38° C

**WARNING:** Before entering the spa or hot tub measure the water temperature with an accurate thermometer

and

**AVERTISSEMENT:** Avant d'utiliser une cuve de relaxation mesurer la température de l'eau à l'aide d'un thermomètre précis

**WARNING:** Do not use a spa or hot tub immediately following strenuous exercise

and

**AVERTISSEMENT:** Ne pas utiliser une cuve de relaxation immédiatement après un exercice fatigant

**WARNING:** Prolonged immersion in a spa or hot tub may be injurious to your health

and

**AVERTISSEMENT:** L'utilisation prolongée d'une cuve de relaxation peut être dangereuse pour la santé

**WARNING:** Do not permit electric appliances (such as a light, telephone, radio, or television) within 5 ft. (1.5m) of the spa or hot tub

and

**AVERTISSEMENT:** Ne pas placer d'appareil électrique (luminaire, téléphone, radio, téléviseur, etc) à moins de 1.5, de cette cuve de relaxation

**WARNING:** Maintain water chemistry in accordance with manufacturer's instruction

and

**AVERTISSEMENT:** La teneur de l'eau en matières dissoutes doit être conforme aux directives du fabricant.

**WARNING:** The use of alcohol or drugs can greatly increase the risk of fatal hyperthermia in hot tubs and spas

and

**AVERTISSEMENT:** La consommation d'alcool ou de drogue augmente considérablement les risques d'hyperthermie mortelle dans une cuve de relaxation.

## **HYPERTHERMIA**

The causes, symptoms, and effects of hyperthermia may be described as follows:

Hyperthermia occurs when the internal temperature of the body reaches a level several degrees above the normal body temperature of 98.6°F (37° C). The symptoms of hyperthermia include drowsiness, lethargy, and an increase in the internal temperature of the body. The effects of hyperthermia include

- (a) unawareness of impending hazard;
- (b) failure to perceive heat;
- (c) failure to recognize the need to exit spas;
- (d) physical inability to exit spa;
- (e) fetal damage in pregnant women; and
- (f) unconsciousness and danger of drowning.



# IMPORTANT SAFETY INSTRUCTIONS

**Caution: Risk of electrical shock. Read and follow all instructions.**

## **1. Read and follow all instructions.** **2. Save these Instructions.**

3. **Never** allow children to access or use this product unless closely supervised by an adult at all times.
4. **Never** connect unit to a power supply with a load controller.
5. **Never** operate spa if the suction fittings are broken or missing.
6. **Never** replace a suction fitting with one rated less than the flow rate marked on the original suction fitting.

The suction fittings in this spa are sized to match the specific water flow created by the pump. Should the need arise to replace the suction fittings or the pump, be sure that the flow rates are compatible.

## **To avoid/reduce risk of injury and/or drowning:**

1. The water temperature in a spa should never exceed 104°F (40°C). This temperature is considered safe for a healthy adult. Lower water temperatures are recommended for young children and elderly adults, and when spa usage exceeds 10 minutes. Consult your physician or pediatrician to determine safe temperature limits.

**NOTE: Refer to information on hyperthermia on page 2.**

2. Since excessive water temperatures have a high potential for causing fetal damage during the early months of pregnancy, pregnant or possibly pregnant women should check with their physician before entering spa.

3. Before entering a spa, the user should verify the water temperature with an accurate thermometer since the tolerance of water temperature regulating devices varies.
4. The use of alcohol, drugs, or medications before or during spa use may lead to unconsciousness with the possibility of drowning.
5. Persons suffering from obesity or with a medical history of heart disease, circulatory problems, or diabetes should consult a physician before using a spa.
6. Persons using medications should consult a physician before using a spa since some medications may induce drowsiness while other medications may affect heart rate, blood pressure, and circulation.

## **To avoid risk of electrical shock:**

1. Only use the wire connector provided on this unit to connect a minimum No. 6 AWG (5.15 mm<sup>2</sup>) solid copper conductor between this unit and any metal equipment, metal enclosures of electrical equipment, metal water pipe, or conduit within 5 ft. (1.5 m) of the unit.
2. Install at least 5 ft. (1.5m) from all metal surfaces. Spa may be installed within 5 feet of a metal surface if each metal surface is permanently connected by a minimum No. 6 AWG (5.15mm<sup>2</sup>) solid copper conductor attached to the wire connector on the terminal box that is provided for this purpose.
3. Do not permit any electric appliance, such as a light, telephone, radio, or television within 5 ft. (1.5m) of a spa.

**NOTE: Check with your state/local code enforcement officer to determine electrical code requirements and compliance. Use a qualified licensed electrician to complete all spa final electric connections.**

The electrical supply for this product must

include a suitably rated switch or circuit breaker to open all ungrounded supply conductors to comply with Section 422-20 of the National Electrical Code (NEC) ANSI/NFPA 70-1987. This disconnecting means must be readily accessible for operation but installed at least 5 ft. (1.5m) from the spa as required to comply with local code requirements. All electrical connections should comply with Article 680-D of the NEC.

4. Install to provide drainage of compartment for electrical components.

### Do's and Don'ts

For years of spa enjoyment:

#### Do:

- **Save these instructions!**
- Replace the cover immediately after use.
- Keep the cover locked when spa is not in use.
- Be aware of the dangers of a wet and slippery surface. Use caution when entering and exiting your spa.
- Have a licensed electrician make all final electrical connections.
- Replace worn, frayed or broken electrical cords.
- Keep the water chemistry correctly balanced. Untreated spa water will cause problems with your spa and equipment as well as being a health risk.
- Clean the spa filter monthly or as needed. (See Filter Maintenance Pg. 24).
- Position the spa so that all sides remain accessible for maintenance.
- Use a bathing cap for long hair.
- Refer to information on hyperthermia (this page).
- Use only authorized spa care products for the best performance and to keep the water properly balanced.

#### Don't:

- Use the spa at 104°F (40°C) for long periods of time (more than 30 minutes). See **Hyperthermia**, this page.
- Use an extension cord to power your spa.
- Allow anyone to stand on the spa cover. It is not

designed to support weight.

- Power the spa unless it is filled with water to the water level mark on the Weir door.
- Operate the pump on high speed for extended periods of time with the cover in place. Extended operation can cause heat build-up and interfere with spa operation.

### Hyperthermia

The causes, symptoms, and effects of hyperthermia may be described as follows: Hyperthermia occurs when the internal temperature of the body reaches a level several degrees above the normal body temperature of 98.6°F (37°C). The symptoms of hyperthermia include an increase in the internal temperature of the body, dizziness, lethargy, drowsiness, and fainting. The effects of hyperthermia include (1) failure to perceive heat, (2) failure to recognize the need to exit spa or hot tub, (3) unawareness of impending hazard, (4) fetal damage in pregnant women, (5) physical inability to exit the spa or hot tub, and (6) unconsciousness resulting in the danger of drowning.

**Warning:** The use of alcohol, drugs, or medication can greatly increase the risk of fatal hyperthermia.

## Spa Installation

**Danger: Electrical shock risk. Install at least 5 ft. (1.5m) from all metal surfaces.**

The electrical supply for this product must include a suitably rated switch or circuit breaker to open all ungrounded supply conductors to comply with Section 422-20 of the National Electrical Code, ANSI/NFPA70-1987. The disconnecting means must be readily accessible but installed at least 5 feet (1.5 meters) from the spa water. All electrical connections should comply with article 680-D of the NEC.

### Site and Positioning

Locate the spa on solid, level foundation or flooring, keeping in mind the weight of the filled spa (in excess of 4,000 lbs. on some models). If you have any doubts about the load bearing ability of your chosen site, contact an architect or a building contractor. The entire perimeter of the spa cabinet and the spa bottom must be evenly supported.

If your spa is installed outdoors, we recommend that you provide a concrete pad for the spa to rest on (8ft. x 8ft. x 4in. level pad). **Failure to provide a level surface could structurally damage your spa and void the warranty.**

The spa must be installed to allow access for service and maintenance on all four sides; therefore, below grade level installation is not recommended.

### Outdoor Installation

The following considerations apply when installing your spa outdoors:

1. Local codes pertaining to fencing.
2. Local electrical and plumbing codes.
3. View from your house.
4. Wind direction.
5. Exposure to sunlight.
6. Location relationship to trees (twigs, leaves and shade).
7. Dressing and bathroom location.
8. Storage area for maintenance equipment and chemicals.
9. Location to facilitate adult supervision.
10. Landscaping and nighttime lighting.
11. Accessibility to equipment.

12. Power supply location and foot traffic.

### Indoor Installation

The following considerations apply when installing your spa indoors:

1. Indoor spas promote high humidity. Using either ventilation fans or commercial grade de-humidifiers will help to reduce the humidity. Consult your dealer for details.
2. **Floor drains must be provided near the spa to drain off water that may cause falls and /or water damage.**
3. Floor area should be flat with a non-skid finish. Carpeting is not recommended.
4. Walls, ceilings, woodwork should be made of materials capable of withstanding high humidity (redwood, cedar).
5. Be sure floor load bearing capacities are adequate to support the concentrated spa weight.
6. Spas should be double checked for leaks before installing to avoid possible water damage. Dealer installation may include this service.
7. Indoor sunrooms are capable of maintaining high ambient temperatures which may effect the spa water temperature. It is **NOT** recommended that you operate your filter cycles for longer than 6 hours per day under these conditions.

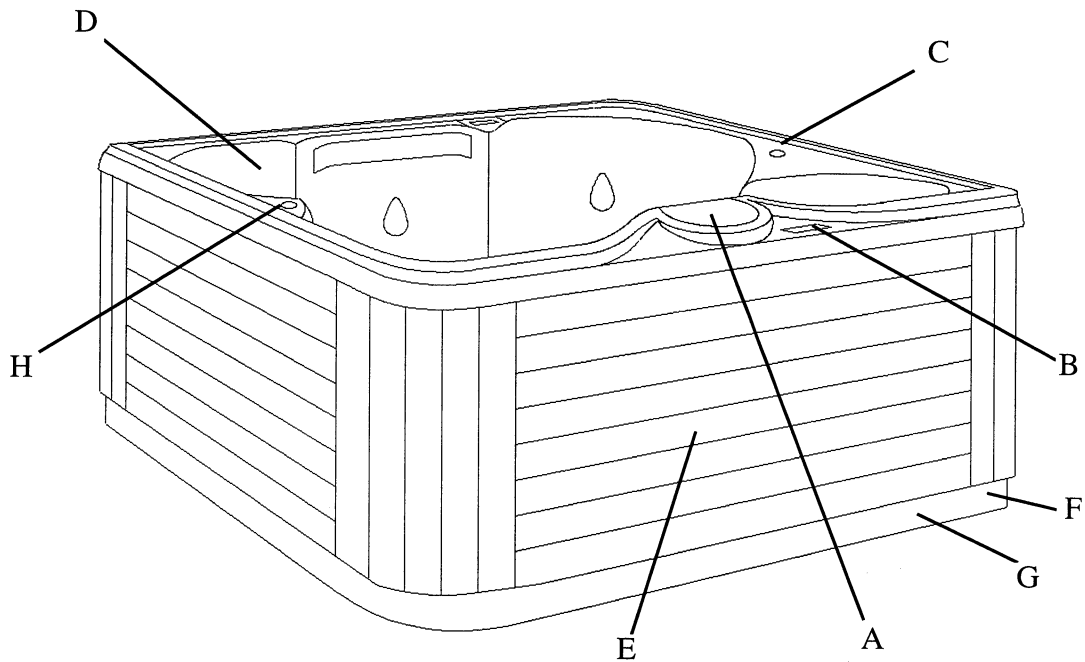

## Spa System Components

- A. Filter Skimmer/Weir Door:** Removes floating debris from the water surface, provides a water return path to equipment, and houses water filter element.
- B. Topside Control Panel:** Used to control temperature setting, pump for jets, and light.
- C. Air Controls:** Increases or decreases air entering the jets. Close during heating for maximum efficiency.
- D. Comfort Collar™ Valve:** Used to control water flow to Comfort Collar jets. (Not applicable to all Models.)
- E. Equipment Pack Service Panel (no user serviceable parts):** Spa support system consisting of one or two pumps, heater, and associated electrical controls (not shown).
- F. Drain Access (Adjacent to the equipment service panel):** Spa drain faucets are located on the kickplate.
- G. Manufacturer's Identification Label:** Contains identification information for warranty service (serial number, model number, etc.) and electrical information (ampere rating and ampere requirements). Located on the kickplate, on the same side as the topside control.
- H. Diverter Valve:** Used to direct the flow of water from jets to the open seating area jets in the spa. (Not applicable to all Models.)

# Spa Components

Reference only. Equipment is not always as shown.

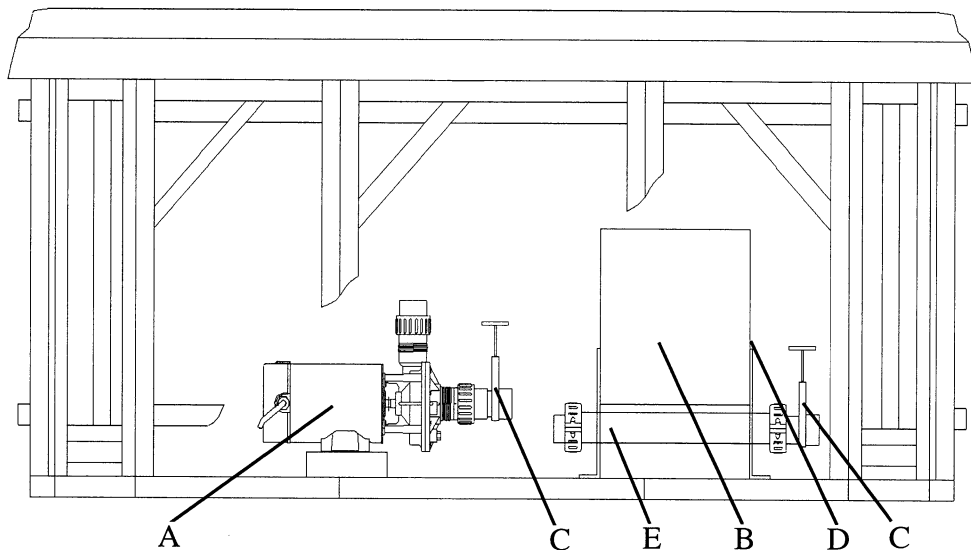

**Note:** No consumer serviceable parts. We recommend that only an authorized service technician perform hot tub repair or service.

- A. Pumps (One pump or two pumps, depending on model):** Low speed for efficient water circulation during filtration and heating; high speed for maximum action of the jets. The pump functions are activated by topside controls.
- B. Warning and Installation Label:** Contains important safety information and installation instructions.
- C. Slice Valve:** Used to shut off water flow from the spa to the equipment while servicing. Quantity will vary depending on model. All should be open during normal operations.
- D. Electrical Connections:** Contains outlets for electrical plug connections. Connections are made during manufacture of the spa.
- E. Heater Assembly:** Thermostatically controlled and equipped with an overheat safety shut-off.

# Jets and Air Controls

## Jets

All spa jets are individually engineered to provide a unique hydro-massage. Depending on the model, your spa will have a combination of the following jets:

### **Cyclone Therapeutic (XL Cyclone, Cyclone, & LS Luxury):**

Positioned to focus on large muscle groups, these jets deliver a concentrated, high volume stream of water for a deep massage. Each jet is fully adjustable, allowing users to set the water flow to the most comfortable setting. The nozzle can be rotated to target sore muscle areas.

### **Cyclone Turbo Swirl Jets (XL Cyclone, Cyclone, & LS Luxury):**

Positioned to focus on muscle tension zones, these jets deliver a spinning V-shaped water stream for a gentle, pulsating massage. Each jet is fully adjustable, allowing users to set the water flow to the most comfortable setting.

### **Whirlpool:**

Positioned to create overall water circulation, this multi-purpose, high volume jet provides whirlpool action throughout the entire spa.

### **Euro Jets:**

Positioned in the footwell area of the spa, these jets deliver a penetrating massage to dissolve tension in the lower legs. This jet is the entry point for ozone produced during the automatic filtration cycles, and, as such, is not adjustable. **Note:** Ozone production is suspended when other functions are activated on the control panel by the spa user.

All full sized jets are adjustable from a fully open to closed position. It is very important that you **NEVER SHUT ALL FULL SIZED JETS OFF AT ONE TIME!**

## Cleaning or Replacing Jets

Hard water can cause calcium/mineral buildup that can restrict or bind the jets. A jet consists of a face plate and a nozzle. Rotate these parts weekly and remove/clean monthly to ensure free movement.

**Note:** It is not necessary to drain the spa to clean or remove the jets.

## Rotating the jet face plate and nozzle

- Rotate the jet face left and right (open and closed).
- Return the face plate to the full open position.
- Turn the jets on to high speed.
- Twist the nozzle left and right.
- Rotate the nozzle in the socket.

**Note:** If the jet insert disengages from the spa housing, see steps to reinstall below.

## Cleaning the jets

To **remove** the jet insert, use the palm of your hand to exert pressure on the face of the jet. Turn counter-clockwise until the jet "clicks". Gently pull the jet assembly from the housing.

To **clean** the jet insert and housing, use a pressurized hose and spray the inside of the jet. Soak the jet in a diluted spa cleaning solution, rinse. Wipe the inside of the housing to remove any debris.

To **reinstall** the jet, insert jet assembly into the housing. Use the palm of your hand to press the face in while turning clock-wise until the nozzle assembly "clicks" back into place.

## Comfort Collar™

Select models in the 400 series are equipped with special above-the-waterline neck jets in the Comfort Collar™. The intensity of the water flow to these jets can be controlled by turning the valve adjacent to the therapy seat.

**Note:** The Comfort Collar™ jets in all Base models are not equipped with a control valve.

## Air Controls

The intensity of the jet action can be controlled by altering the amount of air injected with water through the jets. Your spa has 2 to 4 air controls located on the lip of the spa. Each control activates air to specific jets in the spa allowing you to create various combinations and levels of jet action to suit individual preferences.

Turn the control counter-clockwise to turn the air off and clockwise to turn air on.

**Note:** Air controls should be closed during heating cycles for maximum energy efficiency.

**Note:** If spa is equipped with the Aeromax option, one control should be left open at all times.

## Electrical Information

**Caution: Risk of electrical shock.  
Read and follow all instructions.**

### Important Safety Instructions

All electrical connections to this spa package **MUST** be accomplished by a qualified licensed electrician in accordance with the National Electrical Code (NEC) and with state/local electrical codes in effect at the time of installation.

**NOTE:** Prior to performing any service to the spa equipment, turn **OFF** all primary electrical power at the main circuit breaker or disconnect panel.

To make spa electrical connections, remove the exterior equipment access panel, locate the electrical control box, remove the control box cover and follow the wiring diagram on the inside of the control box cover.

Connections should be made using copper conductors **only**. Connecting wires, circuit breakers, or fuses must all be sized to accommodate the Total Ampere load as specified on the equipment label.

This equipment is designed to operate on 60Hz alternating current only, at 240 volts or 120 volts, as required.

**NOTE:** All unions must be hand-tight and all slice valves must be locked in the **OPEN** position before filling or refilling spa! A clip is provided to help keep the slice valve open. Run spa and check for union leaks before reinstalling front panel.

### Ground-Fault Circuit Interrupter

A qualified licensed electrician shall connect the spa to a circuit protected by a GFCI. This is a requirement by the National Electric Code, article 680-42, and is also in compliance with Underwriter's Laboratories, Inc.

### Installation Options

While knockouts are provided in the cabinet base to bring the conduit to the equipment compartment, a hole may need to be drilled in the pedestal or base if an alternate electrical service entrance is desired.

The 300 Series Model 361 Base is convertible to

either 120 volt or 240 volt electrical service. All other models can **only** be connected to a 240 volt electrical service.

### 120 Volt Installation

#### Model:

- The 300 Series Model 361 Base.

#### Electrical Requirements:

- 120 Volts, 60Hz, Single Phase, 40 amp. or \*20 amp 3-wire service, (including ground.)

#### \*20 Amp Option

**Note: The heater can be activated only with the pump on low speed. Only the light can be operating at the same time without disabling the heater. See your authorized Coleman Spas® dealer to select this option.**

- 300 Series spas installed for 120 volt operation require a 3-wire, 40 amp, 120 volt subfeed in non-metallic pipe to the spa equipment compartment (line 1, neutral and ground). A green colored terminal (or wire connector marked "G", or "GR", "Grounding") is provided in the control box. To reduce the risk of electrical shock, connect this terminal or connector to the grounding terminal of your electrical service or supply panel with a continuous green insulated copper wire equivalent to the circuit conductor supplying this equipment, but no smaller than No. 12 AWG. A second pressure wire connector is provided on the surface of the control box for bonding to local ground points. To reduce the risk of electrical shock, this connector should be bonded with a No. 6 AWG copper wire to any metal ladders, water pipes, or any metal within 5 feet of the spa.

**Copper wire is strongly recommended for all electrical connections.**

### 240 Volt Installation

Permanently Connected

**Models:**

- The 300, 400 and 600 Series models (461, 470, 471, 472, 480, 481, 482, and 605) must be connected to a 240-volt electric service. The 361 Base model is convertible to either 120-volt or 240-volt, but comes factory wired for 240-volt service. The 361 Deluxe model must be connected to a 240-volt service.

**Refer to the manufacturer's nameplate located on the kickplate to determine your spa's ampere requirements.**

**Electrical Requirements:**

- 240 Volts, 60Hz, Single Phase, 50 amp. 4 wire service (line 1, line 2, neutral, and ground) or,

**\*30 Amp Option**

**Note: The heater can be activated only with the pump on low speed. Only the spa light can be operating at the same time without disabling the heater. See your authorized Coleman Spas® dealer to select this option.**

Spas installed for 240 volt operation require a 4-wire, 50 amp., 240 volt subfeed in non-metallic pipe to the spa equipment compartment (line 1, line 2, neutral and ground). A green colored terminal (or wire connector marked "G", or "GR", "Grounding") is provided in the control box. To reduce the risk of electrical shock, connect this terminal or connector to the grounding terminal of your electrical service or supply panel with a continuous green insulated copper wire equivalent to the circuit conductor supplying this equipment, but no smaller than No. 12 AWG. A second pressure wire connector is provided on the surface of the control box for bonding to local ground points. To reduce the risk of electrical shock, this connector should be bonded with a No. 6 AWG copper wire to any metal ladders, water pipes, or any metal within 5 feet of the spa.

**Copper wire is strongly recommended for all electrical connections.**

- 240 Volts, 60Hz, Single Phase, 60 amp. 4 wire service (line 1, line 2, neutral, and ground) or,

**\*40 Amp Option**

**Note: The heater can be activated only with the pump on low speed. Only the spa light can be operating at the same time without disabling the heater. See your authorized Coleman Spas® dealer to select this option.**

Spas installed for 240 volt operation require a 4 wire, 60 amp., 240 volt subfeed in non-metallic pipe to the spa equipment compartment (line 1, line 2, neutral and ground). A green colored terminal (or wire connector marked "G", or "GR", "Grounding") is provided in the control box. To reduce the risk of electrical shock, connect this terminal or connector to the grounding terminal of your electrical service or supply panel with a continuous green insulated copper wire equipment, but no smaller than No. 12 AWG. A second pressure wire connector is provided on the surface of the control box for bonding to local ground points. To reduce the risk of electrical shock, this connector should be bonded with a No. 6 AWG copper wire to any metal ladders, water pipes, or any metal within 5 feet of the spa.

**Copper wire is recommended for all electrical connections.**

**Note: (30 and 40 Amp options)** Units operated at 240 volts must have all electrical connections made by a qualified licensed electrician in accordance with the National Electric Code and state/local codes in effect at the time of installation.

The following table describes the electrical configurations for the control systems.

<u>Input</u>	<u>GFCI Circuit Breaker Size</u>	<u>Dip Switch Position</u>	<u>Heater &amp; High Pump</u>	<u>Heater &amp; Low Pump</u>	<u># of wires Including Ground</u>	<u>Maximum Current Draw</u>
<i>430 Powerworks Series Spa Pack</i>						
120 V/20 Amp	20 Amp / 1-pole	On	No	Yes	3	16
120 V/40 Amp	40 Amp / 1-pole	Off	Yes	Yes	3	35
240 V/30 Amp	30 Amp / 2-pole	On	No	Yes	4	26
240 V/50 Amp	50 Amp / 2-pole	Off	Yes	Yes	4	44
<i>630 Powerworks Series Spa Pack</i>						
240 V/30 Amp	30 Amp / 2-pole	On	No	Yes	4	26
240 V/40 Amp	40 Amp / 2-pole	On	No	Yes	4	35
240 V/50 Amp	50 Amp / 2-pole	Off	Yes	Yes	4	44
240 V/60 Amp	60 Amp / 2-pole	Off	Yes	Yes	4	52

### Controls Applicability

Each control system may be used on several different spa models. The following table identifies the series control number and the spa model it is used on:

<b>Series Control System...</b>	<b>430</b>	<b>432</b>	<b>630</b>
<b>Models used on...</b>	361 Base	361 Deluxe 461 Base 470 Base 471 Base 472 Base 480 Base 481 Base 482 Base	461 Deluxe 470 Deluxe 471 Deluxe 472 Deluxe 480 Deluxe 481 Deluxe 482 Deluxe 605

## Start Up Procedures

Follow recommendations for site location and electrical connection (pgs. 3 and 7). The water line on the weir door (see Filter/Skimmer, pg. 4) is the level at which the water should be maintained.

1. Fill the spa through the filter hole to the water line on the weir door with tap water.

**Never use "softened" water in your spa.** Softened water can impact the chemical balance of the water and lead to degradation of metal plumbing fittings.

2. Turn power on to unit at circuit breaker or disconnect panel.
3. Open the air controls, located on the top lip, and cycle the jets from high to low. Water should come from the therapy jets. If water flow is not established, turn off jets and see Priming Your Spa (this page).
4. Add chemicals. See Chemical treatment and Water Maintenance section (page 23).

Follow Operating Instructions for your particular model to set heat to the desired temperature (See pgs. 13 or 18, Temperature). Initially, you may find that the spa requires 12 to 14 hours on 240 Volt installations to reach temperature. Keep your thermal cover on the unit and close the air controls to help the heating process.

**Important: Do not operate the spa  
without full water flow.**

## Priming Your Spa

When filling your spa for the first time or, after draining and refilling the spa, you may need to bleed air from the system. Should you experience an air-lock, remove the filter basket cover, insert a garden hose through the center hole of the filter as far as possible without using force. Hold the hose in place and turn on the water. This forces water into the pump and forces the air out.

# 630 Series Control System

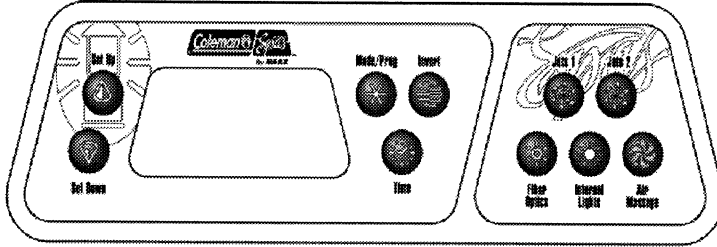

633 Topside Control

If your Topside Control looks like this, your spa has the following features:

- \* Fiber Optics
- \* Internal Lights
- \* Air Massage

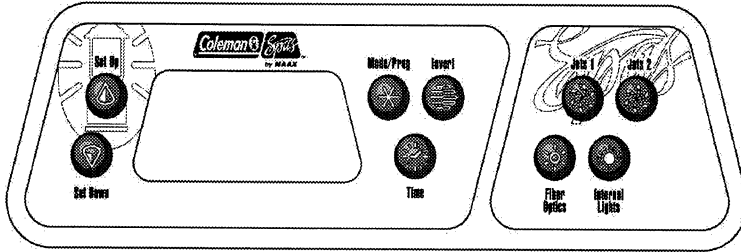

632 Topside Control

If your Topside Control looks like this, your spa has the following features:

- \* Fiber Optics
- \* Internal Lights

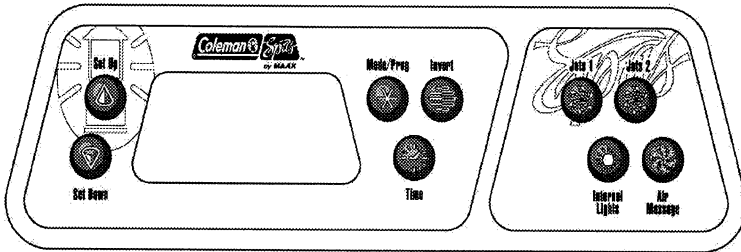

631 Topside Control

If your Topside Control looks like this, your spa has the following features:

- \* Internal Lights
- \* Air Massage

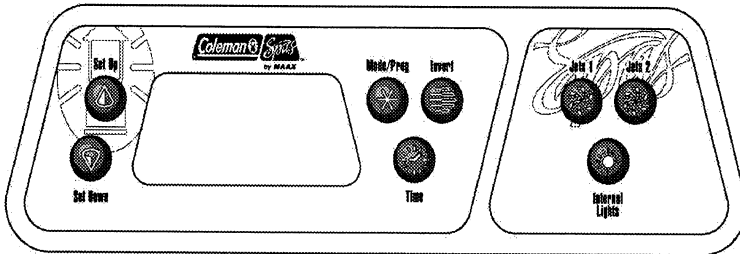

630 Topside Control

If your Topside Control looks like this, your spa has the following features:

- \* Internal Lights

## Control Systems

### Powerworks™ 630 Series Control System











The Powerworks™ 630 Series Control System offers you the ultimate in spa control. The backlit, Liquid Crystal Display (LCD) displays current water temperature, set point water temperature, time, and operating mode settings. Each feature of the system is actuated through a control panel touch pad. Touch the appropriate pad to activate the desired function.

At start up, when power is supplied to the spa, the controls will operate properly and safely under the factory settings. The spa will be in **Standard** Mode, have a temperature setting of 100°F, and a filtration cycle duration of 3 hours. To fully utilize the unique capabilities of the control system, it is important to know how to set the temperature, operate the pumps, operate the light, adjust the mode setting, and change the filtration cycles.

**Note:** In event of a power outage or failure, the 630 Series Control System should retain all settings. If settings are lost, re-program per the instructions in this manual and contact your dealer.

### User's Pads

User's Pads are the buttons located on the topside control panel and are used to program various spa functions (i.e., turn on spa light, set temperature, etc.). The following table defines the pads:

Pad	Use
 <i>Set Up</i>	<ul style="list-style-type: none"> <li>•Increase temperature</li> <li>•Change time settings</li> </ul>
 <i>Set Down</i>	<ul style="list-style-type: none"> <li>•Decrease temperature</li> <li>•Change time settings</li> </ul>
 <i>Fiber Optics</i>	<ul style="list-style-type: none"> <li>•Turn Digital Fiber Optic Lighting System (DOL) on or off (Model 605 only)</li> </ul>
 <i>Internal Lights</i>	<ul style="list-style-type: none"> <li>•Turn internal spa light on or off</li> </ul>
 <i>Mode/Prog</i>	<ul style="list-style-type: none"> <li>•Set or lock/unlock temperatures</li> <li>•Set or lock/unlock panel settings</li> <li>•Switch modes</li> <li>•Set time and filtration cycles</li> </ul>
 <i>Jets 1</i>	<ul style="list-style-type: none"> <li>•Activate primary filtration pump</li> </ul>
 <i>Jets 2</i>	<ul style="list-style-type: none"> <li>•Activate therapy pump</li> </ul>
 <b>Invert</b>	<ul style="list-style-type: none"> <li>•Flip display for easy reading from outside or inside spa</li> </ul>
 <i>Time</i>	<ul style="list-style-type: none"> <li>•Change time of day setting or,</li> <li>•Change set times of spa cycles</li> </ul>
 <i>Air Massage</i>	Optional. Turns blower system on or off. Same as Turbo

## Temperature

The maximum set temperature is 104°F (40°C) and the minimum set temperature is 80°F (27°C). The current water temperature or, if the pump has not been running, two dashes, will show on the display. If dashes are displayed, you must first start the pump by pressing the **JETS 1** pad. Wait until the water temperature is displayed (approximately 2 minutes).

The set temperature of your spa may easily be increased or decreased at any time using the **SET UP** or **SET DOWN** pads. When either of these pads is touched, the set temperature will be displayed in the LCD window. Each successive touch will change the set temperature 1°F in the chosen direction. After 3 seconds the LCD will automatically display the water temperature or dash lines.

If the spa is set in **Standard** mode or in a filtration cycle, adjusting the set temperature may result in activating the heater. When the heater is operating, the word *HEAT* will be displayed in the LCD.

**Note:** 240-Volt spas that are wired with the 30 Amp option will not heat when Pump 1 is on in high speed, or when Pump 2 is in operation.

### JETS 1

Touch the **JETS 1** pad to activate the primary filtration pump. The sequence of the jet action is:

- 1 touch = Low jets
- 2 touches = High jets
- 3 touches = Off

### JETS 2

Touch the **JETS 2** pad to activate the therapy pump. The sequence of jet action is:

- 1 touch = Low jets
- 2 touches = High jets
- 3 touches = Off

The low speed operation of Pump 1 is timed to automatically turn off after four hours of operation. The high speed operation of Pump 1, and the low and high speed operation of Pump 2, is timed to automatically turn off after 30 minutes of operation.

**Note:** Pump 1 will automatically operate in low speed

whenever the spa calls for a filtration cycle or heat. When this automatic activation occurs, the low speed of Pump 1 cannot be turned off; however, all other control functions can be activated.

## Temperature Lock

Once you have set the desired water temperature, you may lock-in the new setting to prevent unauthorized temperature adjustments to your spa. To lock the set temperature:

Touch **SET UP** or **SET DOWN**, then touch **TIME**, then **JETS 1**. The center display will read:



Touch the **SET UP** pad to lock the temperature and the display will read:



You have two seconds to complete this sequence in the correct order. The center display will show the spa temperature along with the lock symbol. The set temperature pads are deactivated and, when pushed, the set temperature appears with a double arrow next to it.

## Temperature Unlock

To unlock the temperature, touch either **SET UP** or **SET DOWN**, then touch **TIME**, then **JETS 1**, and then **SET DOWN**. The unlocked display will read:



The four pads must be pressed in the correct sequence and within two seconds. When the last pad is pressed, the lock symbol will disappear and all pads are active.

## Panel Lock

To help prevent unauthorized use of your spa, the control system has a unique panel locking system.

To lock the panel, touch **TIME**, then **JETS 1**. The center display will read:



Next, touch **SET UP**. The center locked display will read:



You have two seconds to complete this sequence in the correct order. The center display will then show the spa temperature along with the lock symbol. All panel pads are now deactivated except the **TIME** pad, which is used to initiate the Unlock sequence.

When the control panel lock is engaged, all automatic spa functions will operate normally but cannot be altered.

## Panel Unlock

To unlock the panel, touch the **TIME**, then **JETS 1**, and then **SET DOWN** and the unlocked display will read:



Notice that the lock symbol has disappeared. All pads are now reactivated.

**Note:** All three pads must be pressed in the correct sequence that must be completed within two seconds.

## Light

Touch the **LIGHT** pad to turn the internal spa light on and off. The spa light will automatically turn off after 60 minutes of operation.

**Note:** The **LIGHT** pad is also used with optional digital lighting system (See Pg. 16).

## Standard/ Economy/Sleep Modes

Your spa can be switched among **Standard**, **Economy**, and **Sleep Modes** by touching the **MODE/PROG** pad. If your spa is in the **Standard** mode, the low speed of Pump 1 and the heater will come on automatically to maintain the set temperature of the water. If your spa is set in the **Economy** mode, the heater will operate ONLY during the filtration cycles. Pump 1 will circulate for approximately two minutes several times throughout the day to sample water temperature.

If your spa is set in the **Sleep** mode, the heater and pump will operate only during a filtration cycle to maintain the water temperature 20°F below the set temperature.

The selected mode will be displayed in the LCD window of the control panel. When in Standard mode, the word *STANDARD* will be displayed. When in Economy mode, the word *ECONOMY* will be displayed. When in Sleep mode, neither *STANDARD* nor *ECONOMY* will be displayed.

## Setting the Time and Filtration Cycles

This control has been specifically designed so that, by connecting the spa to its properly grounded source and touching the **MODE/PROG** pad, the spa will function properly and safely at 100°F. In this mode, all user pads will be completely functional. However, to fully utilize the unique capabilities of this control, it is important to set the time and filtration cycles.

### Setting the Time

Once the spa has been properly connected, a *SET TIME* message will flash on the LCD screen. Touch the **TIME** pad; then touch the **MODE/PROG** pad. To advance the time, press the **SET UP** pad, or **SET DOWN** pad to decrease the time. Press either of these pads again to stop the time setting cycle. Press **MODE/PROG** to fix the time and exit the Set Time procedure. The water temperature will be displayed.

### Preset Filter Cycles

Now that the time is correctly set, the spa will filter automatically for a 3-hour period every 12 hours. Whenever a filter cycle is active, this automatic filtering sequence is indicated on the LCD screen, as either **Filter 1** or **Filter 2**.

### Filter 1

The first filter cycle is automatically activated at 2:00 a.m. and operates the low-speed pump until 5:00 a.m. The heater will operate in the **Economy** mode.

### Filter 2

The second filter cycle is automatically activated at 2:00 p.m. and operates the low-speed pump until 5:00 p.m. Again, the heater will operate in the Economy mode. During this cycle, a short purge function occurs on the second pump and the blower.

**Note:** To properly clean and maintain spa, a total filter time of at least six hours per day is recommended.

## Changing Filter Cycles

The start/stop times and the duration of each filter cycle can be adjusted, as desired. The amount of time needed to filter your spa will vary depending on usage and ambient conditions. Use the following procedure if a different time or duration is preferred or, if you wish to leave the heater off during filtering.

Touch the **TIME** pad and the center display will read the actual time of day. Touch the **MODE/PROG** pad and Set Time will be displayed. Touch **MODE/PROG** again and the display will read *SET FILTER 1*. Each time the **MODE/PROG** pad is pressed, the Filter-Start time, the Heater-Enable status, and the Filter-Stop time will be indicated on the LCD screen.

When the Filter-Start or Filter-Stop times are displayed, touch **SET UP** or **SET DOWN** to reset the times. When the Set Heat message is displayed, touch **SET UP** or **SET DOWN** to set the center display to ON or OFF. In the ON position, the spa will warm to the set temperature during the filter cycles. In the OFF position, the heater will not be activated during the filter cycles.

**Note:** ON must be displayed to use the heater in the Economy mode. The heater will always remain ON while in Standard mode. In cold weather, Standard settings are recommended.

After entering the Filter-set commands, you must

touch **MODE/PROG** to proceed through all the start and stop times for the second filter cycle. Follow the same procedures to adjust the Filter 2 settings.

**Note:** At the start of the second filtration cycle, Pump 2 is activated to clear the water in the pipe lines and ensure complete filtration.

**Note:** In freezing conditions, do **NOT** override the second filtration cycle.

To exit the Filter-Set procedure, touch **MODE/PROG**. The LCD will display the current water temperature.

## Clean Up Cycle

After periods of heavy use, turn the jets on to **Low Whirlpool** for a four-hour clean up cycle.

## Inversion Feature

The 630 Series Control includes an **Inversion** feature that makes it easy to read the LCD from inside or outside the spa. To invert the LCD display, touch the **Invert** pad. Repeat the sequence to reverse the inversion process.

## Turbo Air Booster Option

Your spa may be optionally equipped with a Turbo Air system to increase the performance and therapeutic action of the jets. To turn the Turbo Air system on and off, touch the **AIR MASSAGE** pad.

**Note:** The Turbo Air blower will shut off automatically after 30 minutes.

**Note:** At the start of a filtration cycle, the blower is activated to purge the lines and ensure complete filtration. Ensure that at least one air control is fully open.

## Air Massage (Model 605 only)

Model 605 may be optionally equipped with the Air Massage feature. Similar to the Turbo Air Booster, additional air injectors in the foot well area generate a vigorous air and water massage action throughout the spa. To turn the Air Massage on or off, touch the **AIR MASSAGE** pad.

**Note:** The Air Massage blower will shut off automatically after 30 minutes.

## Digital/Fiber Optics Lighting (DOL)

All 300 and 400 Series spas may be optionally equipped with a Digital/Fiber Optic Lighting System (DOL) that replaces the internal spa light. This system has different color settings (modes) to enhance your overall spa experience. Each time the DOL system is turned ON by pressing the LIGHT pad, it will begin a different color lighting sequence.

All Model 605 spas are standard equipped with DOL. On this model, touch the FIBER OPTIC pad to turn on or off.

### Accessing Different Light Modes

The default DOL setting is Mode 1 (see below). To change Modes, press the Light or Fiber Optic pad Off and On within a 5 second time period. The light will advance to the next color sequence mode. Continue until the desired color sequence mode is selected. The lighting modes are:

Mode 1: Random color changes, smooth gradual fading between colors.

Mode 2: Solid color mode - Red

Mode 3: Solid color mode - Green

Mode 4: Solid color mode - Blue

Mode 5: Color blend - Red and Green

Mode 6: Color blend - Red and Blue (Violet)

Mode 7: Color blend - Green and Blue (Aqua)

Another change will return to Mode 1

**Note:** Leaving the power OFF for 10 seconds or longer will default the light to Mode 1.

## Ozone Operation

All 300 and 400 Series spas (standard on Model 605) may be optionally equipped with Coleman® Spas' CleanZone™ ozone water treatment system to assist with your water sanitizing needs. All factory installed ozonators are designed to work in conjunction with an injector system to maximize the sanitizing effects by fully mixing the ozone with the water flow.

CleanZone™ will produce ozone only when the spa is in a timed filtration cycle. During the filter cycle, activating other functions will suspend ozone production for 30 minutes.

**Note:** Activating the low speed of Pump 1 for a

clean up cycle will initiate filtration, but not ozone production, unless the spa enters a timed filter cycle during the 4 hour period.

## Optional Entertainment System

(Model 605 only)

The optional JVC® brand audio system is designed to provide the ultimate spa entertainment experience. Power to the entertainment system is supplied at spa startup so it is always ready for your enjoyment.

Refer to the JVC® Owner's Manual included in the Coleman® Spas Owner's Manual packette for instructions on programming and using the entertainment system.

**Read all instructions carefully before using the Entertainment System and Save the Instructions!**

### Stereo Remote Control

The Entertainment System includes a stereo remote control that will operate the stereo by pointing the remote at the equipment enclosure located on the front skirt panel of the spa, or at the IR receiver on the inside lip of the spa. Refer to the JVC® Owner's Manual for instructions.

**Note:** The remote control is *not* waterproof and should not be used from inside the spa.

# 430 Series Control System

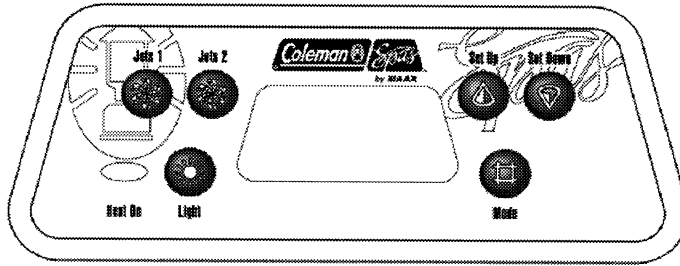

432 Topside Control with Jets 2 Option

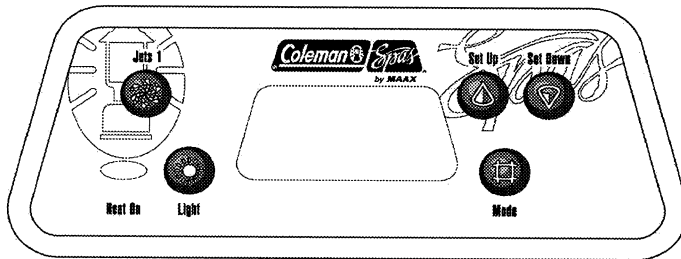

430 Topside Control

## Powerworks™ 430 Series Control System

The 430 Series Powerworks™ Control offers you the ultimate in spa control. The backlit, Liquid Crystal Display (LCD) displays current temperature, set water temperature, and operating mode settings. Each feature is actuated through the control panel pad. Touch the appropriate button to activate the desired function.

At start up, when power is supplied to the spa, the controls will operate properly and safely under the factory settings. The spa will be in Standard mode, have a temperature setting of 100°F, and a filtration cycle duration of 3 hours. To fully utilize the unique capabilities of the control system, it is important to know how to set the temperature, operate the pumps, operate the light, adjust the mode setting, and change the filtration cycle.

### User's Pads

User's Pads are the buttons located on the topside control panel and are used to program various spa functions (i.e., turn on spa light, set temperature, etc.). The following table defines the buttons:

Pad	Use
 Set Up	<ul style="list-style-type: none"> <li>•Increase temperature</li> <li>•Change filter durations</li> </ul>
 Set Down	<ul style="list-style-type: none"> <li>•Decrease temperature</li> <li>•Change filter durations</li> </ul>
 Mode	<ul style="list-style-type: none"> <li>•Set or lock/unlock temperatures</li> <li>•Set or lock/unlock panel settings</li> <li>•Switch modes</li> <li>•Set time and filtration cycles</li> </ul>
 Internal Lights	<ul style="list-style-type: none"> <li>•Turn internal spa light on or off</li> </ul>
 Jets 1	<ul style="list-style-type: none"> <li>•Activate therapy pump</li> </ul>
 Jets 2	<ul style="list-style-type: none"> <li>•Activate therapy pump</li> </ul>
 Heat On	<ul style="list-style-type: none"> <li>•Glow red when on</li> <li>•Shimmers when current water temperature is being taken</li> </ul>

## Temperature Controls

The maximum set temperature of the spa is 104°F (40°C) and the minimum set temperature is 80°F (27°C). The display will show the current water temperature or, if the pump has not been running, two dashes will show on the display. If dashes are displayed, you must first start the pump by pressing the **JETS 1** pad. Wait until the water temperature is displayed (approximately 2 minutes).

The set temperature of your spa may easily be increased or decreased at any time using the **SET UP** or **SET DOWN** pads. When either of these pads is touched, the set temperature will be displayed in the LCD window. Each successive touch will change the set temperature 1°F in the chosen direction. After 3 seconds the LCD will automatically display the water temperature or dash lines.

**Note:** 240-Volt spas that are wired with the 30 Amp option will not heat when Pump 1 is on in high speed, or when Pump 2 is in operation.

If the spa is set in **Standard** mode or in a filtration cycle, adjusting the set temperature may result in activating the heater. When the heater is operating, the **HEAT ON** indicator glows red or shimmers if it is sampling..

**Note:** Model 361 spas that are wired 120V/20 amp will not heat when the pump is on in high speed.

**Note:** Spas that are wired 240V/30 amp will not heat when the pump is on in high speed.

### Jets Low

Touch the **JETS 1** pad to activate the low speed operation of the pump. The sequence of the jet action.

- 1 touch = Low Jets
- 2 touches = High Jets
- 3 touches = Off

### Jets High

Touch the **JETS 2** pad to activate the high speed operation of the pump. The sequence of the jet action is:

- 1 touch = High Jets
- 2 touches = Off

The low-speed operation of Pump 1 is timed to

automatically turn off after four hours of operation. The high speed operation of Pumps 1 and 2 is timed to automatically turn off after 30 minutes of operation.

**Note:** The Pump 1 will automatically operate in low speed whenever the spa calls for a filtration cycle or heat. When this automatic activation occurs, the low speed operation of Pump 1 can not be turned off; however, all the other control functions can be activated.

## Light

Touch the **LIGHT** pad to turn the internal spa light on or off. The light will automatically turn off after 60 minutes of operation.

## Standard/Economy/Sleep Mode

Your spa can be switched among **Standard**, **Economy**, and **Sleep Modes** by touching the **MODE** pad. If your spa is in the **Standard** mode, the low speed of Pump 1 and the heater will come on automatically to maintain the set temperature of the water. If your spa is set in the **Economy** mode, the heater will operate ONLY during the filtration cycles. Pump will circulate for approximately two minutes several times throughout the day to sample water temperature.

If your spa is set in the **Sleep** mode, the heater and pump will operate only during a filtration cycle to maintain the water temperature 20°F below the set temperature.

The selected mode will be displayed in the LCD window of the control panel. When in **Standard** mode, *STD* will be displayed. When in **Economy** mode, *ECN* will be displayed. When in **Sleep** mode, *SLP* will be displayed.

## Filtration Cycles

This control has been specifically designed so that by simply connecting the spa to its properly grounded source and touching the **MODE** pad, the spa will function properly and safely at 100°F. In this mode, all user pads will be completely functional. However, to fully utilize the unique capabilities of this control, it is important to set the filtration cycles.

### Preset Filter Cycles

Your control system is designed with two filter cycles. The first filter cycle will turn on six minutes after power is supplied to the spa. The second filter will turn on 12 hours later. The filter cycles are preset at the factory for a 3 hour duration. For example: Spa is plugged in at 8:00AM:

Filter cycle #1 will run from 8:06AM to 11:06AM.

Filter cycle #2 will run from 8:06PM to 11:06PM.

At the start of each filter cycle, Pump 1 will come on in low speed. The heater will operate on demand if the controls are set in the **Economy** mode. If your spa is equipped with an ozone generator, it will be activated 60 seconds into the cycle.

### Changing Filter Cycles

The duration of a filter cycle can be set from one hour per cycle to 12 hours per cycle and will run twice in a 24 hour period. For example, a 1 hour cycle will complete once every 12 hours for a total of 2 hours per day, and a 12 hour cycle, running twice per day will filter continuously for the entire 24 hour period. The amount of time needed to filter your spa will vary depending on usage and ambient conditions. You will need to program your filter cycles based upon your personal use.

To change the duration of the filter cycles touch the **SET UP** or **SET DOWN** pad and then touch the **JETS 1** pad. The center display will read:

FIL3

Touch the **SET UP** or **SET DOWN** pad to adjust the cycle duration to the desired setting. After each press, the duration of the cycle will be displayed in the LCD window as follows:

FIL1	1 Hour for each cycle, 2 hours per day
FIL2	2 Hours for each cycle, 4 hours per day
FIL3	3 Hours for each cycle, 6 hours per day
FIL4	4 Hours for each cycle, 8 hours per day
FIL5	5 Hours for each cycle, 10 hours per day
FIL6	6 Hours for each cycle, 12 hours per day
FIL7	7 hours for each cycle, 14 hours per day
FIL8	8 hours for each cycle, 16 hours per day
FIL9	9 hours for each cycle, 18 hours per day
FIL A	10 hours for each cycle, 20 hours per day
FIL B	11 hours for each cycle, 22 hours per day
FIL C	12 hours for each cycle, 24 hours per day

To exit the filter-set procedure, touch **JETS 1**. The LCD window will display the current water temperature or dash lines.

If a change is made to the duration while the spa is in a filtration cycle, it will take effect immediately. If the change is made outside a filtration cycle, it will take effect at the start of the next scheduled cycle.

To change the starting times of your daily filtration cycles, you must turn off the circuit breaker to your spa and turn it back on at the desired start time for the first cycle.

**Note:** When power to the spa is denied (disconnect, power outage), the controls may revert to the default factory settings. Any adjustments to set temperature or filter cycle duration may need to be reprogrammed.

### Clean Up Cycle

After periods of heavy use, you can manually start a clean-up cycle by turning Pump 1 on in low speed. The pump will operate for 4 hours and then automatically turn off. The heater will also operate during this period if the controls are set in **Standard** mode.

## Digital/Fiber Optic Lighting System(DOL)

All 300 and 400 Series spas may be optionally equipped with a Digital/Fiber Optic Lighting System (DOL) that replaces the internal spa light. This system has different color settings (modes) to enhance your overall spa experience. Each time the DOL system is turned ON by pressing the LIGHT pad, it will begin a different color lighting sequence.

### Accessing Different Light Modes

The default DOL setting is Mode 1 (see below). To change Modes, press the Light or Fiber Optic pad Off and On within a 5 second time period. The light will advance to the next color sequence mode. Continue until the desired color sequence mode is selected. The lighting modes are:

Mode 1: Random color changes, smooth gradual fading between colors.

Mode 2: Solid color mode - Red

Mode 3: Solid color mode - Green

Mode 4: Solid color mode - Blue

Mode 5: Color blend - Red and Green

Mode 6: Color blend - Red and Blue (Violet)

Mode 7: Color blend - Green and Blue (Aqua)

Another change will return to Mode 1

**Note:** Leaving the power OFF for 10 seconds or longer will default the light to Mode 1.

## Ozone Operation

All 300 and 400 Series spas (standard on Model 605) may be optionally equipped with Coleman® Spas' CleanZone™ ozone water treatment system to assist with your water sanitizing needs. All factory installed ozonators are designed to work in conjunction with an injector system to maximize the sanitizing effects by fully mixing the ozone with the water flow.

CleanZone™ will produce ozone only when the spa is in a timed filtration cycle. During the filter cycle, activating other functions will suspend ozone production for 30 minutes.

**Note:** Activating the low speed of Pump 1 for a clean up cycle will initiate filtration, but not ozone production, unless the spa enters a timed filter cycle during the 4 hour period.

## Equipment Safety Features

### Automatic Time Outs

Your spa is equipped with an automatic Time Out feature designed to protect both the equipment and the user. For your safety and to reduce unnecessary use of the pumps and lights, the Time Out feature turns selected accessories off automatically, as follows:

Accessory	Mode	Shuts off in....
Pump 1	Low	4 hours
Pump 2	Low	30 minutes
Pump 1	High	30 minutes
Pump 2	High	30 minutes
Blower		30 minutes
Light		1 hour
Fiber Optic		1 hour

### Common LCD Equipment Safety Messages

The following table describes the most common messages, possible causes, and corrective actions:

If the LCD displays...	Indicates...	What happens ...	Possible cause...	Corrective action
<b>OHH</b>	Overheat - one of the sensors has detected water temperature of 118°F+ inside the heater	Spa heater will automatically shut down until temperature falls below 108°F	<ul style="list-style-type: none"> <li>- Low speed pump operating for an extended period of time</li> <li>- Programming error causing continuous filtering</li> </ul>	<ul style="list-style-type: none"> <li>- Make sure slice valves are open.</li> <li>- Reprogram to ensure time cycles not overlapping</li> <li>- Contact dealer if problem persists</li> </ul>
<b>OHS</b>	Overheat - One sensor has detected temperature of spa water entering heater to be 110°F+	Spa heater will automatically shut down until temperature falls below 108°F	<ul style="list-style-type: none"> <li>- Low speed pump operating for an extended period of time</li> <li>- Programming error causing continuous filtering</li> </ul>	<ul style="list-style-type: none"> <li>- Make sure slice valves are open.</li> <li>- Reprogram to ensure time cycles not overlapping</li> <li>- Contact dealer if problem persists</li> </ul>
<b>HFL</b>	Heater flow problem	Heater will shut down while spa continues to function normally	<ul style="list-style-type: none"> <li>- Plugged filter</li> <li>- Low water</li> </ul>	<ul style="list-style-type: none"> <li>- Remove filter and clean</li> <li>- Add water</li> <li>- Contact dealer or service person</li> </ul>

## Common LCD Equipment Safety Messages (continued)

<b>If the LCD displays...</b>	<b>Indicates...</b>	<b>What happens ...</b>	<b>Possible cause...</b>	<b>Corrective action</b>
<b>LF</b>	Water flow problem - Persistent flow problem	Heater will shut down while spa continues to function normally	- Plugged filter  - Low water	- Remove filter and clean  - Add water  - Contact dealer or service person
<b>drY</b>	No water to the heater	Spa functions will shut down	- Slice valves closed  - Blocked suction returns  - Blocked filter/skimmer	- Open valves  - Remove blockage  - Remove blockage  - Contact dealer
<b>dr</b>	Lack of water to the heater	Heater will shut down while spa continues to function normally	- Slice valves closed  - Blocked suction returns  - Blocked filter/skimmer	- Open valves  - Remove blockage  - Remove blockage  - Contact dealer
<b>SnA</b>	Heater sensor A not functioning	Spa automatically deactivated	Non-functioning sensor	Contact dealer for replacement sensor
<b>Snb</b>	Heater sensor B not functioning	Spa automatically deactivated	Non-functioning sensor	Contact dealer for replacement sensor
<b>Sns</b>	Heater sensors are out of balance		—	Contact dealer

## Common LCD Messages

The following table defines other messages you will frequently see on the LCD display:

<b>Message...</b>	<b>What it is...</b>	<b>What it means....</b>
<b>Pr</b>	Priming mode	Spa is in normal Priming Mode operation
<b>SLP</b>	Sleep mode	Spa is in normal Sleep Mode operation
<b>Ecn</b>	Economy mode	Spa is in normal Economy Mode operation
<b>Std</b>	Standard mode	Spa is in normal Standard Mode operation
<b>ICE</b>	Freeze condition	Heater will come on to keep water above 45°F
<b>--</b>	Water temperature	Current water temperature not measured

# Maintenance

## Water Chemistry

Water chemistry is critical in a spa system. Chemicals are used to sanitize the water and control the pH balance. The combination of high water temperature and small water volume means that the chemical balance must be watched carefully. It is recommended that you purchase a chemical start up kit, and the additional chemicals needed to maintain the proper/optimum chemical balance, from your dealer.

## Sanitizing

Sanitizing the water destroys harmful organisms and keeps your spa healthy and safe. Three commonly used spa sanitizers or oxidizing agents are bromine, chlorine and ozone. Chlorine or bromine are chemicals that you add to the water. Ozone is a gas that is produced by an ozonator and injected into the water. It is important that a residual of sanitizer remain in your water. High water temperature, aeration and use will increase the need for sanitizer.

In addition to maintaining a residual, it is important to “shock” your spa water periodically and after heavy use. This addition of substantial amounts of sanitizer super-chlorinates the water and oxidizes non-filterable organic residue. Allow the sanitizer level to drop back to the residual amount before using. Also use your Clean Up Cycle (See pgs. 15 and 19) after heavy use for additional filtration.

Tests should be done **daily** with your test kit to keep a chlorine or bromine residual of 3.0 to 5.0 ppm.

## pH Level

pH is the balance of acidity and alkalinity in the water. Maintaining proper pH is important for the effectiveness of your sanitizer, for user comfort, and to prevent corrosion of the spa equipment.

**Caution: Never** mix two chemicals together.

**Caution: Never** store chemicals in the equipment compartment.

**Caution: Do not use muriatic acid** to balance pH as it will damage your spa surface and equipment.

## Recommended Levels

pH:	7.2–7.6 (Ideal 7.4–7.6)
Sanitizer Residual:	3.5–5.0 ppm
Total Dissolved Solids:	100–200 ppm
Free Available Sanitizer:	3.0–5.0 ppm

Total Alkalinity: 80–100 ppm ideal for dichlor, trichlor, and bromine.

**Note:** Make sure you use fresh test kit strips/chemicals. Test kits and test chemicals should be stored in a cool, dry location. Check the manufacturer’s instructions to determine shelf life and expiration date.

## Water Maintenance With the CleanZone™ Water Treatment System

Equipping your spa with a Coleman® Clean Zone™ system that includes the Powerworks™ Ozonator is a smart decision. CleanZone™ treats the water in your spa with a specialized ozone application. The use of ozone in conjunction with spa sanitizing and water balancing chemicals provides you with a cleaner, healthier spa, reduces chemical usage, and protects your skin from chemically induced irritation.

## Sanitizing With Ozone

Spas vary in size, and frequency and conditions of use. For this reason you will need to establish your sanitizing program based upon your own personal use. When using ozone, you should start by balancing your water chemistry as you normally would. A spa should run and be ozonated a minimum of six hours per day. If your spa is heavily used, this run time should be increased. Your spa produces ozone during the filtration cycles (Pgs. 16 and 20).

The amount of a residual sanitizer (chlorine or bromine) that you maintain in the water will also vary depending on use. It is recommended that you maintain a residual of 3.0–5.0 ppm. Periodically, and after periods of heavy use, it is necessary to “shock” your spa with large amounts of sanitizer.

**Note:** Extra filtration can be provided by manually starting a clean-up cycle. Turn Pump 1 on in low speed. The pump will operate for 4 hours and then automatically turn off. The heater will also operate during this period if the controls are set in **Standard** mode.

## Specialty Chemicals

While ozone may significantly reduce the usage of specialty chemicals (chlorine and bromine), it is not a substitute for these chemicals. All chemicals should continue to be monitored, especially during periods of heavy usage and when changing or replenishing the spa water.

## Draining Your Spa

**Note:** Always turn the circuit breaker off when you drain your spa. Do not turn the spa heater back on until you have full flow coming from the jets for several minutes.

High concentrations of impurities caused by water evaporation, body oils, perfumes, and other contaminants may accumulate in the spa and cannot be filtered out. Consequently, it is advisable to drain your spa and refill it with fresh water every six to eight weeks or more often, depending on the amount of use.

All spas are equipped with both external and internal drains. The external drain is used for draining the spa. The internal drain(s) are used to remove water from internal hoses when Winterizing your spa (See pg. 25) or if the water is severely contaminated.

**Note:** Use a standard garden hose to direct the water to an appropriate disposal area.

The **external** drain valve is located at the base of the spa below the side panel. Remove the outer black cap and connect a garden hose to the fitting. Turn the ring on the back of the valve counter-clockwise until it stops, then pull out to open the valve. Water will begin to flow. When flow stops, push in the valve, turn ring clockwise until it stops, remove hose and replace the cap.

The **internal** drain hose(s) are located behind the front access panel. Remove the access panel screws and the access panel. Locate the drain hose(s). For each hose drain valve, remove the cap, attach the garden hose, and turn the valve handles, located on the drain valve body, 90° counter-clockwise. Water will begin to flow. When all water has been evacuated, turn the valve handle clockwise until it stops. Remove garden hose and replace the cap. Repeat for each internal drain hose.

**Note:** Do **NOT** attempt to use the pump to drain the spa.

**Note:** Close and replace caps on all drains **prior** to refilling the spa.

**Note:** When refilling the spa, you may need to bleed air from the system. Refer to Priming Your Spa, pg. 10, for instructions.

## Filter Maintenance

**Note:** It is not necessary to drain the spa in order to clean the filters.

The removable filter cartridge is located in the filter canister behind the skimmer. The filter should be inspected/cleaned monthly during normal use, and more often when spa use is heavy.

Your filtration system may also include First Filter, an additional filter that is placed on top of the skimmer basket and pressed into place. This filter aids the collection of microscopic organic matter, debris, hair, soap residue and body oils. To clean this filter, remove, rinse or soak in cartridge cleaner as directed, and reinstall. When First Filter is no longer white after cleaning, replace with a new filter. These can be purchased from your dealer.

**Keep the filter cartridge clean!** Clean the filter cartridge at least once every 90 days. A clogged filter decreases performance and degrades water quality.

To clean the filter cartridge:

1. Turn the pump off.
2. Remove skimmer lid on top of spa.
3. Remove strainer basket.
4. Remove filter cartridge from the filter canister by grasping the top and lifting upwards.
5. Soak filter in a commercial filter cleaner/ degreaser, available from your Coleman Spa dealer, per manufacturer's instructions. Hose out filter cartridge or replace with new cartridge, if needed.
6. Place filter cartridge back into filter canister. When the spa is empty, the weir door may block the filter canister. You must hold it out of the way when reinstalling the cartridge. When the spa is full, the door will float so you will have easy access for installing the filter cartridge.
7. Replace strainer basket and skimmer lid.
8. Turn the pump ON.

Replacing the filter cartridge annually is recommended to maintain optimum performance. Filter maintenance depends on usage.

## Winterizing

In cold climates where freezing temperatures occur, special care is required to prevent the possibility of damage to the spa and equipment due to freezing.

If you plan on using your spa during cold months, be sure your pump and heater are in good working order. The spa shell has been insulated to provide efficient operation in cold weather areas.

**Note:** If you elect not to drain your spa and the temperature is going to be below freezing for extended periods of time, it is best to operate the spa heater at the maximum high temperature (to 104°F), especially if there is a power outage threat. This will help keep the spa water from freezing if you have a power failure.

If you do not intend to use your spa during the winter months and there is danger of freezing, use the following steps to winterize your spa:

1. Turn off all electrical power to the spa.
  2. Drain spa and hoses of all water using the directions for Draining Your Spa (pg. 24). Open all unions, and remove drain plugs from bottom of pumps. If you cannot draw off all of the water (especially from hoses), add Recreational Vehicle antifreeze to the remaining water through the bottom of the skimmer and jets. If antifreeze is used, it must be an inhibitor Propylene Glycol such as Dow Frost™, available through Dow Chemical® distributors.
- Note:** Prior to refilling the spa, drain all antifreeze from spa and hoses using the instructions for Draining Your Spa (Pg. 24 ). Carefully monitor chemicals until all antifreeze residue has dissipated.
3. The filter should be drained, and the cartridge removed and cleaned.
  4. Check to see that there is no water in the heater element chamber.
  5. Clean your spa as directed in the following two sections on this page.
  6. Cover your spa with a water-shedding, impenetrable cover.
  7. For further information on blowing out the plumbing lines and winterizing procedures, contact your local dealer.

## Spa Cabinet Care

The 300, 400, and 600 series cabinets are made of Duramaax™, a high quality alternative to wood that is virtually maintenance free, requiring no staining, sealing, or waxing.

**Never use abrasive cleaners.**

To clean the spa cabinet, rinse dirt and dust regularly with clear water. To remove stubborn dirt, grime, and mild discoloration, wash with a mild detergent and warm water.

## Spa Surface Care and Cleaning

Your spa shell surface is made of acrylic. A minimum amount of care and cleaning will keep your spa looking new for years.

Use a spa cleaner for residue and lime buildup at the water level of the spa surface. It may be necessary to lower the water level 2 to 3 inches before cleaning to avoid polluting the spa.

Cleaner can be applied to the acrylic surface with a soft cloth and wiped clean. Use a non-abrasive household cleaner to clean your spa shell (Lysol Basin, Tub & Tile Cleaner®, Glass Plus®, Mr. Clean®, etc.) or use a mild dishwashing detergent such as Ivory® Liquid. Rinse well and dry with a clean cloth.

**Note:** Do not allow the acrylic surface to come in to contact with products such as acetone (nail polish remover), nail polish, dry cleaning solution, lacquer thinners, gasoline, pine oil, etc.

Remove dust and dry dirt with a soft, damp cloth. Clean grease, oil, paint and ink stains with isopropyl (rubbing) alcohol. Avoid using razor blades or other sharp instruments that might scratch the surface.

**Protect spa finish - always keep cover on the spa when not in use.**

## Light Bulbs

The Spa light bulb is serviceable from the spa cabinet. Remove the side panel and insulation closest to the light; locate the bracket that holds the bulb. Turn the black bulb holder 90 degrees counter-clockwise; remove from bracket. Pull bulb straight out and replace. Insert bulb holder back into bracket and turn 90 degrees clockwise to secure.

## Common Water Problems

<b>Problem</b>	<b>Cause</b>	<b>Solution</b>
Cloudy Water	<ul style="list-style-type: none"> <li>Inadequate filtration/dirty filter</li> <li>Excessive oils/organic matter</li> <li>Improper sanitation/bacteria</li> <li>High pH and/or high alkalinity</li> <li>Suspended particles/organic matter</li> <li>High total dissolved solids (TDS)</li> </ul>	<ul style="list-style-type: none"> <li>Check to make sure the filter is running properly; clean filter with a filter cleaner or degreaser.</li> <li>Shock the spa with a chlorine or bromine sanitizer, or other shock treatment product.</li> <li>Increase sanitizer level to balance water and shock if needed.</li> <li>Adjust pH; add appropriate sodium bisulfate product.</li> <li>Use clarifier.</li> <li><b>Note:</b> If using an ozone generator or CleanZone™, do not use polymer based clarifiers.</li> <li>Depending on the severity, drain the spa to half and refill, or drain the spa completely, clean and refill.</li> </ul>
Water Odor	<ul style="list-style-type: none"> <li>Excessive organics or chloramines; insufficient free available sanitizer</li> <li>Improper sanitation</li> <li>Inadequate filtration</li> <li>Low pH</li> </ul>	<ul style="list-style-type: none"> <li>Shock the spa with a chlorine or bromine sanitizer/shock, or other shock treatment product.</li> <li>Increase sanitizer level to balance water; shock if needed.</li> <li>Check to make sure the filter is running properly; clean filter with a filter cleaner or degreaser.</li> <li>Raise pH with sodium bicarbonate product. If metals are present, add chelating agent.</li> </ul>
Chlorine Odor	<ul style="list-style-type: none"> <li>Too many chloramines/insufficient free available chlorine</li> <li>Low pH</li> </ul>	<ul style="list-style-type: none"> <li>Shock the spa with a chlorine sanitizer/shock, or non-chlorine shock treatment.</li> <li>Adjust pH; raise pH with sodium bicarbonate product.</li> </ul>
Bromine Odor/ Yellow Water	<ul style="list-style-type: none"> <li>Low pH</li> </ul>	<ul style="list-style-type: none"> <li>Adjust pH; raise pH with sodium bicarbonate product.</li> </ul>
Musty Odor	<ul style="list-style-type: none"> <li>Bacterial or algae growth</li> </ul>	<ul style="list-style-type: none"> <li>Shock spa with a chlorine or bromine sanitizer/shock, or equivalent shock treatment product. If problem is visible, <u>drain, clean, refill and balance spa.</u></li> </ul>
Foaming/Scum Ring Around the Tub	<ul style="list-style-type: none"> <li>Build up of body oils, lotion and chemicals resulting from soap or detergent</li> </ul>	<ul style="list-style-type: none"> <li>Skim foam off using your leaf net or, drain and refill.</li> </ul>
Algae	<ul style="list-style-type: none"> <li>pH Imbalance</li> <li>Low free chlorine or bromine</li> </ul>	<ul style="list-style-type: none"> <li>Adjust pH</li> <li>Shock with a chlorine or bromine</li> </ul>

## Common Water Problems (continued)

Problem	Cause	Solution
Eye Irritation	<ul style="list-style-type: none"> <li>• Low pH</li> <li>• Insufficient free available chlorine</li> </ul>	<ul style="list-style-type: none"> <li>• Raise pH with sodium bicarbonate product.</li> <li>• Shock with a chlorine sanitizer/shock or other shock treatment product.</li> </ul>
Skin Irritation/ Rash	<ul style="list-style-type: none"> <li>• Unsanitary/polluted water</li> <li>• Soaking too long</li> <li>• Chemicals not balanced, excessive ozone</li> </ul>	<ul style="list-style-type: none"> <li>• Keep recommended sanitizer residual at all times; superchlorinate or use a non-chlorine shock treatment.</li> <li>• Soak for smaller intervals, such as 15 minutes.</li> <li>• Correct chemical imbalance.</li> </ul>
Scale	<ul style="list-style-type: none"> <li>• Too much calcium dissolved in water pH and total alkalinity too high</li> </ul>	<ul style="list-style-type: none"> <li>• Add a scale control product. Adjust total alkalinity and pH levels by adding the appropriate sodium bisulfate product; for concentrated scale deposits - drain spa, scrub the scale off, refill the spa and balance the water.</li> </ul>
Erratic pH Test Results/Unusual pH Test Color	<ul style="list-style-type: none"> <li>• Sanitizer level too high</li> <li>• Old pH indicator dye</li> </ul>	<ul style="list-style-type: none"> <li>• Test the pH, when the sanitizer level is below 5 ppm.</li> <li>• Replace the pH indicator dye.</li> </ul>
Sanitizer Dissipating Too Rapidly	<ul style="list-style-type: none"> <li>• Excessive organics in water</li> <li>• Temperature too high</li> <li>• Low pH</li> <li>• Low pH Corrosion of Metal Fixtures</li> <li>• Low calcium hardness</li> <li>• Low total alkalinity</li> </ul>	<ul style="list-style-type: none"> <li>• Increase shock dosage; add sanitizer; shower before entering spa.</li> <li>• Reduce temperature.</li> <li>• Raise pH with sodium bicarbonate product.</li> <li>• Use chelating agent if metals are present. Keep proper pH level (7.2 to 7.6).</li> <li>• Use chelating agent if metals are present. Maintain minimum 150-200 ppm calcium hardness.</li> <li>• Use chelating agent if metals are present. Maintain proper alkalinity for type of sanitizer used.</li> </ul>

**Note:** If your source water has a high metal or mineral content, a specialty chemical should be used to avoid staining or accumulation of deposits.

These guidelines cover the most common water problems when operating a spa with ozone. Contact your dealer for further information regarding chemical control issues.

## Common Hardware Problems

<b>Problem</b>	<b>Usual Cause</b>	<b>Solution</b>
System not operating.	<ul style="list-style-type: none"> <li>• House circuit breaker tripped or in OFF position.</li> </ul>	<ul style="list-style-type: none"> <li>• Reset circuit breaker on house breaker panel.</li> </ul>
Heater not operating	<ul style="list-style-type: none"> <li>• Water level too low.</li> <li>• Heater mode not selected.</li> <li>• No power to heater.</li> <li>• Heater not operating.</li> </ul>	<ul style="list-style-type: none"> <li>• Add water to reach fill line on Weir door.</li> <li>• Refer to temperature/heater functioning. See Control instructions pgs. 9-15.</li> <li>• Check house circuit breaker.</li> <li>• Contact dealer.</li> </ul>
Water not clean.	<ul style="list-style-type: none"> <li>• Clogged or blocked floor suction or skimmer.</li> <li>• Filter clogged (dirty).</li> <li>• Poor water chemistry.</li> <li>• Insufficient filtering time.</li> <li>• Improper maintenance.</li> <li>• High content of solids in water.</li> </ul>	<ul style="list-style-type: none"> <li>• Clean floor suction/skimmer. Remove blockage.</li> <li>• Clean or replace.</li> <li>• See Maintenance section, pg. 16.</li> <li>• Run filtration mode longer.</li> <li>• See Maintenance section, pg. 16.</li> <li>• Use clarifier or drain and refill spa.</li> </ul>
Abnormal water usage.	<ul style="list-style-type: none"> <li>• Excessive evaporation and/or splashing.</li> </ul>	<ul style="list-style-type: none"> <li>• Use spa cover and refill as necessary.</li> </ul>
Overheating	<ul style="list-style-type: none"> <li>• High ambient temperature</li> </ul>	<ul style="list-style-type: none"> <li>• Contact dealer.</li> </ul>
Low water flow from jets.	<ul style="list-style-type: none"> <li>• Operating in FILTER mode-low speed.</li> <li>• Clogged or blocked suction or skimmer.</li> <li>• Dirty filter.</li> <li>• Jets in OFF position.</li> <li>• Slice valves closed.</li> </ul>	<ul style="list-style-type: none"> <li>• Select hi-speed jets.</li> <li>• Clean floor suction/skimmer. Remove blockage.</li> <li>• Clean or replace.</li> <li>• Open jets.</li> <li>• Open slice valves.</li> </ul>
No water flow from jets.	<ul style="list-style-type: none"> <li>• Pump not primed.</li> <li>• Adjustable jets turned off.</li> <li>• House circuit breaker tripped, no power to system.</li> <li>• Faulty pump or motor.</li> <li>• Pump surges.</li> <li>• Slice valves closed.</li> </ul>	<ul style="list-style-type: none"> <li>• See Priming section page 10.</li> <li>• Turn on jets.</li> <li>• Reset circuit breaker at house panel.</li> <li>• Contact dealer.</li> <li>• Low water. Check level on weir door.</li> <li>• Open slice valves.</li> </ul>

## Common Hardware Problems (continued)

<b>Problem</b>	<b>Usual Cause</b>	<b>Solution</b>
Noisy pump and motor.	<ul style="list-style-type: none"> <li>• Clogged floor suction or skimmer.</li> <li>• Low water level.</li> <li>• Damaged or worn motor bearings.</li> </ul>	<ul style="list-style-type: none"> <li>• Clean floor suction/skimmer.</li> <li>• Add water to normal water level (6" below lip).</li> <li>• Contact dealer.</li> </ul>
Water leakage from under spa.	<ul style="list-style-type: none"> <li>• Check unions &amp; drain hoses.</li> </ul>	<ul style="list-style-type: none"> <li>• Close or tighten as necessary.</li> </ul>
No air flow from jets.	<ul style="list-style-type: none"> <li>• Air control not open.</li> <li>• Jet nozzle not seated properly.</li> <li>• Jet nozzle missing.</li> </ul>	<ul style="list-style-type: none"> <li>• Open control.</li> <li>• Check jet nozzles.</li> <li>• Inspect jets and replace as needed.</li> </ul>
Motor will not operate.	<ul style="list-style-type: none"> <li>• House circuit breaker tripped or in OFF position.</li> <li>• Improper or defective wiring or electrical supply.</li> <li>• Thermal Overload Protection switch tripped.</li> </ul>	<ul style="list-style-type: none"> <li>• Reset circuit breaker</li> <li>• Contact dealer.</li> <li>• Auto reset after motor has cooled. Contact dealer if motor continues to cycle.</li> </ul>
Black powder film around water line.	<ul style="list-style-type: none"> <li>• Wearing in of turbo/blower brushes.</li> </ul>	<ul style="list-style-type: none"> <li>• Will disappear after use.</li> </ul>
The spa will not shut off	<ul style="list-style-type: none"> <li>• Spa trying to heat</li> <li>• Spa is in filter cycle</li> <li>• Spa is in standard Mode.</li> </ul>	<ul style="list-style-type: none"> <li>• Check "Set Temperature" in Standard mode</li> <li>• Normal. No need to change.</li> <li>• Check mode setting.</li> </ul>

## Spa Soaking Guidelines

1. Persons with heart disease, diabetes, blood pressure or circulatory abnormalities, a serious illness, or pregnant women should not enter a spa without prior consultation with their doctor.
2. People with skin, ear, genital or other body infections, open sores, or wounds should not use the spa because of the possibility of spreading infection.
3. Before entering, look at the water in your spa. If there is cloudiness, foaming, or if a strong chlorine smell is present, the water needs treatment. Properly maintained water will greatly reduce potential skin rash (pseudomonas). Ask your Authorized Coleman® Spas Dealer for guidance.
4. Shower with soap and water before and after using the spa. Showering before use removes many common skin bacteria, perspiration, lotions, deodorants, creams, etc. that may reduce the effectiveness of the sanitizer and lessen the ability of the filter to work efficiently. Showering after use will help reduce skin irritation that may result from contact with spa chemicals.
5. Enter the spa slowly and cautiously. Be careful of your footing, and allow your body to gradually adjust to the water temperature. Exit slowly to accommodate relaxed leg muscles and possible lightheadedness.
6. Soaking for too long may cause some users to feel nauseous, dizzy, or lightheaded. If you wish to soak in high temperature water (104°F or 40°C), leave the spa after 15 minutes, shower, cool down and then return for another brief stay. In lower temperatures (e.g. 98.6°F—normal body temperature) most people can comfortably and safely soak for longer periods at one sitting. If you have any questions about what's right for you, your family, or other guests, consult your doctor.
7. Be sure you check the water temperature before entering, and while using the spa.
8. Never use the spa while under the influence of alcohol.
9. Consult your doctor about potential harmful effects of using drugs or medications while hot water soaking.
10. **Never use the spa when you are alone.**
11. **Never allow children or elderly adults to use the spa unsupervised.**

# 630 Series System Wiring Diagram

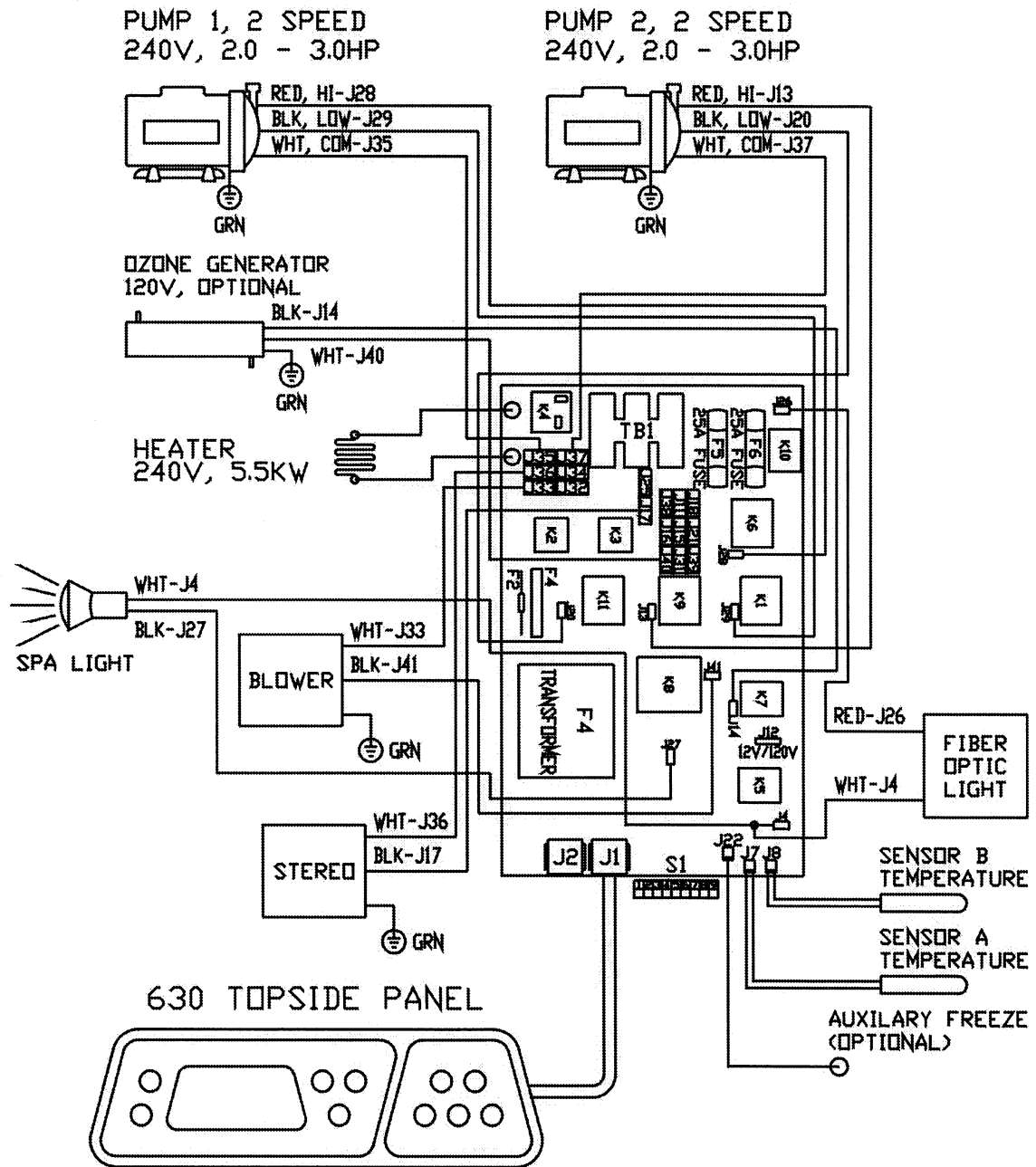

# 432 Series System Wiring Diagram

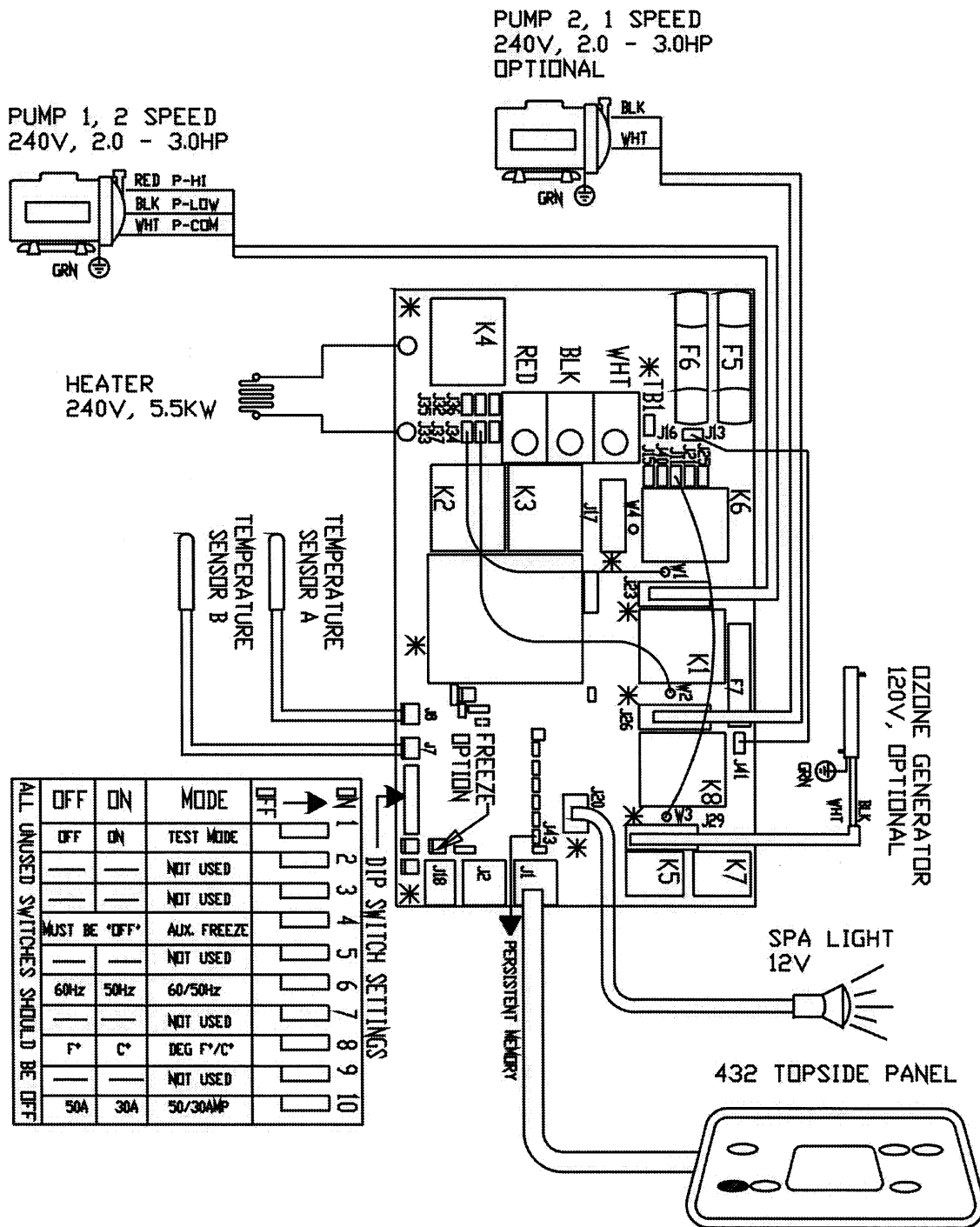

# 430 Series System Wiring Diagram

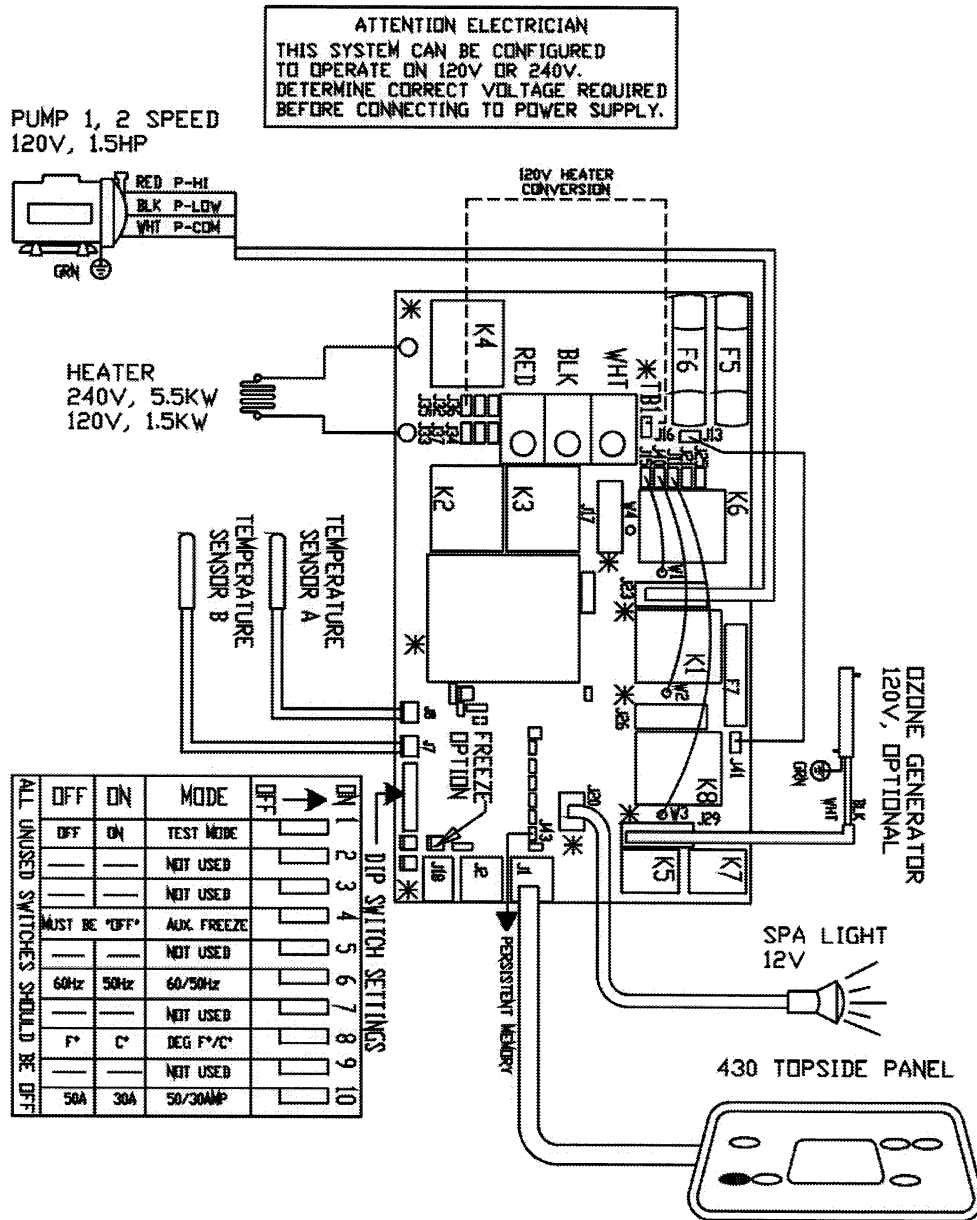

- 240V TO 120V HEATER CONVERSION INSTRUCTIONS:**
1. CONVERSION MUST BE PERFORMED BY A QUALIFIED LICENSED ELECTRICIAN. HARDWARE ONLY.
  2. DISCONNECT FROM POWER & REMOVE WIRE/CORD.
  3. INSTALL WIRE TO CONNECT J-16 TO J-35 AS INDICATED BY DASHED LINE.
  4. INSTALL 120V 3-WIRE LINE TO TBI TERMINAL BLOCK.
  5. IF CONNECTED TO A 20 AMP BREAKER, SET DIP SWITCH 10 TO THE "ON" POSITION.

## **Safety Sign**

The safety sign enclosed with your Owner's Manual should be permanently installed where visible to all users of the spa.

This sign is adhesive backed and includes four screws for mounting the sign on rough surfaces.

It is very important that you, as a spa owner, review the important safety instructions and warnings before you operate your spa. It is equally important that you instruct all users, even occasional ones, as to the warnings associated with spa use.

You may obtain additional signs by contacting:

MAAX SPAS ARIZONA  
Customer Service  
25605 South Arizona Avenue  
Chandler, Arizona 85248

## **Limited Warranty Summary**

Please refer to the Warranty Card included with your product for complete warranty information.

In order to receive prompt warranty service, you must return your warranty card, completed with model and serial number, to MAAX Spas (Arizona), Inc. immediately upon completion of spa installation.

MAAX Spas (Arizona), Inc. provides a limited warranty to our customers. It applies to the spa structure, surface, plumbing, pumps, heater, blower, and controls.

The limited warranty does not cover damage resulting from improper maintenance, improper installation, misuse, abuse, accident, fire, normal wear and tear, or improper water maintenance. Unauthorized modifications of the spa may void the warranty. Replacement costs associated with transportation, removal, and reinstallation are the sole responsibility of the spa owner.

This manual refers to only year 2003 model spas. MAAX Spas (Arizona), Inc. reserves the right to make changes in design or material of its products at any time without incurring liability. This limited warranty applies to the first retail purchaser and terminates upon any transfer of ownership.

103063 REV.06/03  
Retail Value \$9.95US



25605 South Arizona Avenue, Chandler, Arizona 85248  
©1993-2003MAAX Spas (Arizona), Inc. • Printed in U.S.A.

